

2025 CFA[®]
Exam Prep

SchweserNotes[™]
Quantitative Methods and Economics

Level II Book 1

KAPLAN SCHWESER

Kaplan Schweser's Path to Success

Level II CFA[®] Exam

CFA[®]

Welcome

As the head of Advanced Designations at Kaplan Schweser, I am pleased to have the opportunity to help you prepare for the CFA[®] exam. Kaplan Schweser has decades of experience in delivering the most effective CFA exam prep products in the market and I know you will find them to be invaluable in your studies.

Our products are designed to be an integrated study solution across print and digital media to provide you the best learning experience, whether you are studying with a physical book, online, or on your mobile device.

Our core product, the SchweserNotes[™], addresses all of the Topics, Learning Modules, and LOS in the CFA curriculum. Each reading in the SchweserNotes has been broken into smaller, bite-sized modules with Module Quizzes interspersed throughout to help you continually assess your comprehension. Online Topic Quizzes appear at the end of each Topic to help you assess your knowledge of the material before you move on to the next section.

All purchasers of the SchweserNotes receive online access to the Kaplan Schweser online platform (our learning management system or LMS) at www.Schweser.com. In the LMS, you will see a dashboard that tracks your overall progress and performance and also includes an Activity Feed, which provides structure and organization to the tasks required to prepare for the CFA exam. You also have access to the SchweserNotes, Module Quizzes, and Topic Quizzes content as well as the Module Videos (if purchased), which contain a short video that complements each module in the SchweserNotes. Look for the icons indicating where video content, Module Quizzes, and Topic Quizzes are available online. I strongly encourage you to use the dashboard to track your progress and stay motivated.

Again, thank you for trusting Kaplan Schweser with your CFA exam preparation. We're here to help you throughout your journey to become a CFA charterholder.

Regards,

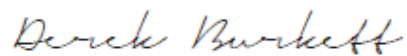

Derek Burkett, CFA, FRM, CAIA

Vice President (Advanced Designations)

Contact us for questions about your study package, upgrading your package, purchasing additional study materials, or for additional information:

888.325.5072 (U.S.) | +1 608.779.8327 (Int'l.)

staff@schweser.com | www.schweser.com/cfa

Book 1: Quantitative Methods and Economics

SchweserNotes™ 2025

Level II CFA®

KAPLAN  **SCHWESER**

SCHWESERNOTES™ 2025 LEVEL II CFA® BOOK 1: QUANTITATIVE METHODS AND ECONOMICS

©2024 Kaplan, Inc. All rights reserved.

Published in 2024 by Kaplan, Inc.

ISBN: 978-1-0788-4647-9

These materials may not be copied without written permission from the author. The unauthorized duplication of these notes is a violation of global copyright laws and the CFA Institute Code of Ethics. Your assistance in pursuing potential violators of this law is greatly appreciated.

“Kaplan Schweser is a CFA Institute Prep Provider. Only CFA Institute Prep Providers are permitted to make use of CFA Institute copyrighted materials which are the building blocks of the exam. We are also required to create / use updated materials every year and this is validated by CFA Institute. Our products and services substantially cover the relevant curriculum and exam and this is validated by CFA Institute. In our advertising, any statement about the numbers of questions in our products and services relates to unique, original, proprietary questions. CFA Institute Prep Providers are forbidden from including CFA Institute official mock exam questions or any questions other than the end of reading questions within their products and services.

CFA Institute does not endorse, promote, review or warrant the accuracy or quality of the product and services offered by Kaplan Schweser. CFA Institute®, CFA® and “Chartered Financial Analyst®” are trademarks owned by CFA Institute.”

Certain materials contained within this text are the copyrighted property of CFA Institute. The following is the copyright disclosure for these materials: “© Copyright CFA Institute”.

Disclaimer: The Schweser study tools should be used in conjunction with the original readings as set forth by CFA Institute. The information contained in these study tools covers topics contained in the readings referenced by CFA Institute and is believed to be accurate. However, their accuracy cannot be guaranteed nor is any warranty conveyed as to your ultimate exam success. The authors of the referenced readings have not endorsed or sponsored these study tools.

CONTENTS

Learning Outcome Statements (LOS)

Welcome to the 2025 Level II SchweserNotes™

QUANTITATIVE METHODS

READING 1

Multiple Regression

Exam Focus

Module 1.1: Basics of Multiple Regression and Underlying Assumptions

Module 1.2: Evaluating Regression Model Fit and Interpreting Model Results

Module 1.3: Model Specification

Module 1.4: Extensions of Multiple Regression

Key Concepts

Answer Key for Module Quizzes

READING 2

Time-Series Analysis

Exam Focus

Module 2.1: Linear and Log-Linear Trend Models

Module 2.2: Autoregressive (AR) Models

Module 2.3: Random Walks and Unit Roots

Module 2.4: Seasonality

Module 2.5: ARCH and Multiple Time Series

Key Concepts

Answer Key for Module Quizzes

READING 3

Machine Learning

Exam Focus

Module 3.1: Types of Learning and Overfitting Problems

Module 3.2: Supervised Learning Algorithms

Module 3.3: Unsupervised Learning Algorithms and Other Models

Key Concepts

Answer Key for Module Quizzes

READING 4

Big Data Projects

Exam Focus

Module 4.1: Data Analysis Steps
Module 4.2: Data Exploration
Module 4.3: Model Training and Evaluation
Key Concepts
Answer Key for Module Quizzes

Topic Quiz: Quantitative Methods

ECONOMICS

READING 5

Currency Exchange Rates: Understanding Equilibrium Value

Exam Focus

Module 5.1: Forex Quotes, Spreads, and Triangular Arbitrage

Module 5.2: Mark-to-Market Value, and Parity Conditions

Module 5.3: Exchange Rate Determinants, Carry Trade, and Central Bank Influence

Key Concepts

Answer Key for Module Quizzes

READING 6

Economic Growth

Exam Focus

Module 6.1: Growth Factors and Production Function

Module 6.2: Growth Accounting and Influencing Factors

Module 6.3: Growth and Convergence Theories

Key Concepts

Answer Key for Module Quizzes

Topic Quiz: Economics

Formulas

Appendix A: Student's T-Distribution

Appendix B: F-Table at 5% (Upper Tail)

Appendix C: Chi-Squared Table

Index

Learning Outcome Statements (LOS)

1. Multiple Regression

The candidate should be able to:

- a. describe the types of investment problems addressed by multiple linear regression and the regression process.
- b. formulate a multiple linear regression model, describe the relation between the dependent variable and several independent variables, and interpret estimated regression coefficients.
- c. explain the assumptions underlying a multiple linear regression model and interpret residual plots indicating potential violations of these assumptions.
- d. evaluate how well a multiple regression model explains the dependent variable by analyzing ANOVA table results and measures of goodness of fit.
- e. formulate hypotheses on the significance of two or more coefficients in a multiple regression model and interpret the results of the joint hypothesis tests.
- f. calculate and interpret a predicted value for the dependent variable, given the estimated regression model and assumed values for the independent variable.
- g. describe how model misspecification affects the results of a regression analysis and how to avoid common forms of misspecification.
- h. explain the types of heteroskedasticity and how it affects statistical inference.
- i. explain serial correlation and how it affects statistical inference.
- j. explain multicollinearity and how it affects regression analysis.
- k. describe influence analysis and methods of detecting influential data points.
- l. formulate and interpret a multiple regression model that includes qualitative independent variables.
- m. formulate and interpret a logistic regression model.

2. Time-Series Analysis

The candidate should be able to:

- a. calculate and evaluate the predicted trend value for a time series, modeled as either a linear trend or a log-linear trend, given the estimated trend coefficients.
- b. describe factors that determine whether a linear or a log-linear trend should be used with a particular time series and evaluate limitations of trend models.
- c. explain the requirement for a time series to be covariance stationary and describe the significance of a series that is not stationary.
- d. describe the structure of an autoregressive (AR) model of order p and calculate one- and two-period-ahead forecasts given the estimated coefficients.
- e. explain how autocorrelations of the residuals can be used to test whether the autoregressive model fits the time series.
- f. explain mean reversion and calculate a mean-reverting level.
- g. contrast in-sample and out-of-sample forecasts and compare the forecasting accuracy of different time-series models based on the root mean squared error criterion.
- h. explain the instability of coefficients of time-series models.

- i. describe characteristics of random walk processes and contrast them to covariance stationary processes.
- j. describe implications of unit roots for time-series analysis, explain when unit roots are likely to occur and how to test for them, and demonstrate how a time series with a unit root can be transformed so it can be analyzed with an AR model.
- k. describe the steps of the unit root test for nonstationarity and explain the relation of the test to autoregressive time-series models.
- l. explain how to test and correct for seasonality in a time-series model and calculate and interpret a forecasted value using an AR model with a seasonal lag.
- m. explain autoregressive conditional heteroskedasticity (ARCH) and describe how ARCH models can be applied to predict the variance of a time series.
- n. explain how time-series variables should be analyzed for nonstationarity and/or cointegration before use in a linear regression.
- o. determine an appropriate time-series model to analyze a given investment problem and justify that choice.

3. Machine Learning

The candidate should be able to:

- a. describe supervised machine learning, unsupervised machine learning, and deep learning.
- b. describe overfitting and identify methods of addressing it.
- c. describe supervised machine learning algorithms—including penalized regression, support vector machine, k-nearest neighbor, classification and regression tree, ensemble learning, and random forest—and determine the problems for which they are best suited.
- d. describe unsupervised machine learning algorithms—including principal components analysis, k-means clustering, and hierarchical clustering—and determine the problems for which they are best suited.
- e. describe neural networks, deep learning nets, and reinforcement learning.

4. Big Data Projects

The candidate should be able to:

- a. identify and explain steps in a data analysis project.
- b. describe objectives, steps, and examples of preparing and wrangling data.
- c. evaluate the fit of a machine learning algorithm.
- d. describe objectives, methods, and examples of data exploration.
- e. describe methods for extracting, selecting and engineering features from textual data.
- f. describe objectives, steps, and techniques in model training.
- g. describe preparing, wrangling, and exploring text-based data for financial forecasting.

5. Currency Exchange Rates: Understanding Equilibrium Value

The candidate should be able to:

- a. calculate and interpret the bid–offer spread on a spot or forward currency quotation and describe the factors that affect the bid–offer spread.

- b. identify a triangular arbitrage opportunity and calculate its profit, given the bid–offer quotations for three currencies.
- c. explain spot and forward rates and calculate the forward premium/discount for a given currency.
- d. calculate the mark-to-market value of a forward contract.
- e. explain international parity conditions (covered and uncovered interest rate parity, forward rate parity, purchasing power parity, and the international Fisher effect).
- f. describe relations among the international parity conditions.
- g. evaluate the use of the current spot rate, the forward rate, purchasing power parity, and uncovered interest parity to forecast future spot exchange rates.
- h. explain approaches to assessing the long-run fair value of an exchange rate.
- i. describe the carry trade and its relation to uncovered interest rate parity and calculate the profit from a carry trade.
- j. explain how flows in the balance of payment accounts affect currency exchange rates.
- k. explain the potential effects of monetary and fiscal policy on exchange rates.
- l. describe objectives of central bank or government intervention and capital controls and describe the effectiveness of intervention and capital controls.
- m. describe warning signs of a currency crisis.

6. Economic Growth

The candidate should be able to:

- a. compare factors favoring and limiting economic growth in developed and developing economies.
- b. describe the relation between the long-run rate of stock market appreciation and the sustainable growth rate of the economy.
- c. explain why potential GDP and its growth rate matter for equity and fixed income investors.
- d. contrast capital deepening investment and technological progress and explain how each affects economic growth and labor productivity.
- e. demonstrate forecasting potential GDP based on growth accounting relations.
- f. explain how natural resources affect economic growth and evaluate the argument that limited availability of natural resources constrains economic growth.
- g. explain how demographics, immigration, and labor force participation affect the rate and sustainability of economic growth.
- h. explain how investment in physical capital, human capital, and technological development affects economic growth.
- i. compare classical growth theory, neoclassical growth theory, and endogenous growth theory.
- j. explain and evaluate convergence hypotheses.
- k. describe the economic rationale for governments to provide incentives to private investment in technology and knowledge.
- l. describe the expected impact of removing trade barriers on capital investment and profits, employment and wages, and growth in the economies involved.

WELCOME TO THE 2025 LEVEL II SCHWESERNOTES™

Thank you for trusting Kaplan Schweser to help you reach your goals. We are pleased that you have chosen us to assist you in preparing for the Level II CFA Exam. In this introduction, I want to explain the resources included with these SchweserNotes, suggest how you can best use Schweser materials to prepare, and direct you towards other educational resources you will find helpful as you study for the exam.

Besides the SchweserNotes themselves, there are many educational resources available at Schweser.com. Log in using the individual username and password that you received when you purchased your SchweserNotes.

SchweserNotes™

These notes consist of five volumes that include complete coverage of all 10 Topic areas and all 371 Learning Outcome Statements (LOS). Examples and Module Quizzes (multiple-choice questions) are provided along the way to help you master the material and check your progress. At the end of each major topic area, you can take an online Topic Quiz for that subject. Topic Quiz questions are created to be exam-like in format and difficulty, to help you evaluate how well your study of each topic has prepared you for the actual exam.

Practice Questions

Studies have shown that to retain what you learn, it is essential that you quiz yourself often. For this purpose we offer SchweserPro™ QBank, which contains thousands of Level II practice questions and explanations. Questions are available for each module and topic. Build your own quizzes by specifying the topics and the number of questions.

SchweserPro™ QBank is an important learning aid for achieving the depth of proficiency needed at Level II. It should not, however, be considered a replacement for rehearsing with “exam-type” questions as found in our Schweser Mock Exams.

Mock Exams

Schweser offers six full-length mock exams: Schweser Mock Exams 1 through 6 each contain complete 88-question tests, with answer explanations. These are important tools for gaining the speed and skills you will need to pass the exam. You can use our Performance Tracker to monitor how you are performing compared to other Schweser Level II candidates.

How to Succeed

The Level II CFA exam is a formidable challenge (42 readings and 371 Learning Outcome Statements), so you must devote considerable time and effort to be adequately prepared.

There is no shortcut! You must learn the material, know the terminology and techniques, understand the concepts, and be able to answer 88 questions quickly and mostly-correctly. Fifteen hours per week for 25 weeks is a useful estimate of the study time required on average, but different candidates will need more or less time, depending on their individual backgrounds and experience.

There is no way around it; CFA Institute will test you in a way that will reveal how well you know the Level II curriculum. You should begin early and stick to your study plan. Read the SchweserNotes and complete the Module Quizzes. Prepare for and attend a live class, an online class, or a study group each week. Take quizzes often using SchweserPro QBank, and go back to review previous topics regularly. At the end of each topic area, take the online Topic Quiz to check your progress. You should try to finish reading the curriculum at least four weeks before the Level II exam so that you have sufficient time for Mock Exams and for further review of those topics that you have not yet mastered.

I would like to thank Kent Westlund, CFA Content Specialist, for his contributions to the 2025 Level II SchweserNotes for the CFA Exam.

Best regards,

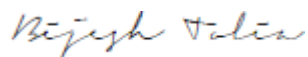
A handwritten signature in blue ink that reads "Bijesh Tolia".

Dr. Bijesh Tolia, CFA, CA

VP of CFA Education and Level II Manager

Kaplan Schweser

READING 1

MULTIPLE REGRESSION

EXAM FOCUS

Multiple linear regression models explain the variation in a dependent variable using more than one independent variables. You should know how to use an F -test to test the effectiveness of nested models. Become familiar with the effects that heteroskedasticity, serial correlation, and multicollinearity have on regression results, and be able to identify common model misspecifications. Finally, understand the role of influential observations in the estimated model, and the use of logistic regression models.

MODULE 1.1: BASICS OF MULTIPLE REGRESSION AND UNDERLYING ASSUMPTIONS



Video covering this content is available online.

LOS 1.a: Describe the types of investment problems addressed by multiple linear regression and the regression process.

Given the complexities of financial and economic relations, a simple one-factor linear regression model is usually inadequate. **Multiple regression** models allow for consideration of multiple underlying influences (independent variables) on the dependent variable.

We can use multiple regression models to:

- 1. Identify relationships between variables:** For example, an analyst may perform exploratory analysis of the factors that influence returns on small-cap stocks. Or, the analyst may wish to determine if the three-factor Fama-French model (market, size, and style) actually adequately explains cross-sectional returns for a sample time period.
- 2. Forecast variables:** For example, an analyst may seek to forecast cash flows for a company, or to predict the probability of company default.
- 3. Test existing theories:** For example, analysts may want to assess if corporate debt issuers with high levels of intangibles on their balance sheet (in addition to other known factors) explain credit risk premiums for those issuers.

Warm-Up: Multiple Regression Basics

The general multiple linear regression model is:

$$Y_i = b_0 + b_1X_{1i} + b_2X_{2i} + \dots + b_kX_{ki} + \epsilon_i$$

where:

Y_i = i th observation of the dependent variable Y , $i = 1, 2, \dots, n$

X_j = independent variables, $j = 1, 2, \dots, k$

X_{ji} = i th observation of the j th independent variable

b_0 = intercept term

b_j = slope coefficient for each of the independent variables

ϵ_i = error term for the i th observation

n = number of observations

k = number of independent variables

The multiple regression methodology estimates the intercept and slope coefficients such that the sum of the squared error terms, $\sum_{i=1}^n \epsilon_i^2$, is minimized. The result of this process is the following regression equation:

$$\hat{Y}_i = \hat{b}_0 + \hat{b}_1X_{1i} + \hat{b}_2X_{2i} + \dots + \hat{b}_kX_{ki}$$

where the $\hat{}$ indicates an estimate for the corresponding regression coefficient

The **residual**, $\hat{\epsilon}_i$, is the difference between the observed value, Y_i , and the predicted value from the regression, \hat{Y}_i :

$$\hat{\epsilon}_i = Y_i - \hat{Y}_i = Y_i - (\hat{b}_0 + \hat{b}_1X_{1i} + \hat{b}_2X_{2i} + \dots + \hat{b}_kX_{ki})$$

The Level I curriculum covered simple linear regression and the t-test for statistical significance of the slope coefficient. For Level II, in order to interpret regression results, we can alternatively use the **p-value** to evaluate the null hypothesis that a slope coefficient is equal to zero.

The p -value is the smallest level of significance for which the null hypothesis can be rejected. We test the significance of coefficients by comparing the p -value to the chosen significance level:

- If the p -value is less than the significance level, the null hypothesis can be rejected.
- If the p -value is greater than the significance level, the null hypothesis cannot be rejected.

LOS 1.b: Formulate a multiple linear regression model, describe the relation between the dependent variable and several independent variables, and interpret estimated regression coefficients.

Let's illustrate multiple regression using research by Arnott and Asness (2003).¹ As part of their research, the authors tested the hypothesis that future 10-year real earnings growth in the S&P 500 (EG10) can be explained by the trailing dividend payout ratio of the stocks in the index (PR) and the yield curve slope (YCS). YCS is calculated as the difference between the 10-year T-bond yield and the 3-month T-bill yield at the start of the period. All three variables are measured in percent.

Formulating the Multiple Regression Equation

The authors formulated the following regression equation using annual data (46 observations):

$$EG10 = b_0 + b_1PR + b_2YCS + \varepsilon$$

The results of this regression are shown in Figure 1.1.

Figure 1.1: Coefficient and Standard Error Estimates for Regression of EG10 on PR and YCS

	Coefficient	Standard Error
Intercept	-11.6%	1.657%
PR	0.25	0.032
YCS	0.14	0.280

Interpreting the Multiple Regression Results

The interpretation of the estimated regression coefficients from a multiple regression is the same as in simple linear regression for the intercept term, but somewhat different for the slope coefficients:

- The **intercept term** is the value of the dependent variable when the independent variables are all equal to zero.
- Each slope coefficient is the estimated change in the dependent variable for a 1-unit change in that independent variable, *holding the other independent variables constant*. For this reason, the slope coefficients in a multiple regression are sometimes called **partial slope coefficients**.

For example, regarding the real earnings growth model, we can make these interpretations:

- *Intercept term*: If the dividend payout ratio is zero and the slope of the yield curve is zero, we would expect the subsequent 10-year real earnings growth rate to be -11.6%.
- *PR coefficient*: If the payout ratio increases by 1%, we would expect the subsequent 10-year earnings growth rate to increase by 0.25%, *holding YCS constant*.
- *YCS coefficient*: If the yield curve slope increases by 1%, we would expect the subsequent 10-year earnings growth rate to increase by 0.14%, *holding PR constant*.

Let's discuss the interpretation of the multiple regression slope coefficients in more detail. Suppose we run a regression of the dependent variable Y on a single independent variable X_1 and get the following result:

$$Y = 2.0 + 4.5 X_1$$

The appropriate interpretation of the estimated slope coefficient is that if X_1 increases by 1 unit, we would expect Y to increase by 4.5 units.

Now suppose we add a second independent variable X_2 to the regression and get the following result:

$$Y = 1.0 + 2.5 X_1 + 6.0 X_2$$

Notice that the estimated slope coefficient for X_1 changed from 4.5 to 2.5 when we added X_2 to the regression. We expect this to happen when a second variable is included.

Now the interpretation of the estimated slope coefficient for X_1 is that if X_1 increases by 1 unit, we would expect Y to increase by 2.5 units, *holding X_2 constant*.

LOS 1.c: Explain the assumptions underlying a multiple linear regression model and interpret residual plots indicating potential violations of these assumptions.

Assumptions underlying a multiple regression model include:

- A linear relationship exists between the dependent and independent variables.
- The residuals are normally distributed.
- The variance of the error terms is constant for all observations.
- The residual for one observation is not correlated with that of another observation.
- The independent variables are not random, and there is no exact linear relation between any two or more independent variables.

Residual plots allow analysts to get a preliminary indication of violation of regression assumptions. We will discuss formal statistical tests for the detection of violation of (the last three) regression assumptions later.

A normal quantile-quantile plot (usually called simply a **Q-Q plot**), is used to compare a variable's distribution to that of a normal distribution. We can employ a Q-Q plot to evaluate the standardized residuals of a regression model: the residuals should lie along a diagonal if they follow a normal distribution. Recall that 5% of normally distributed observations should be below -1.65 standard deviations.

EXAMPLE: Office rent model

An analyst wants to model the determinants of rents for office properties in a large city in the United States. Using a sample of 191 observations, she has estimated the following model:

$$\text{rent}_i = b_0 + b_1 \text{age}_i + b_2 \text{distance}_i + b_3 \text{restaurant}_i + \varepsilon_i$$

where:

rent = monthly rent per square feet (\$)

age = age of the property (in years)

distance = distance from the nearest metro station (in miles)

restaurant = number of lunch locations within walking distance

Regression Output:

Coefficients	Estimate	Std. Error
(Intercept)	44.67	2.01
Age	-0.31	0.05
Distance	-0.01	0.001
Restaurant	1.29	0.29

Exhibit 1: Plot of Residual vs. Predicted Values

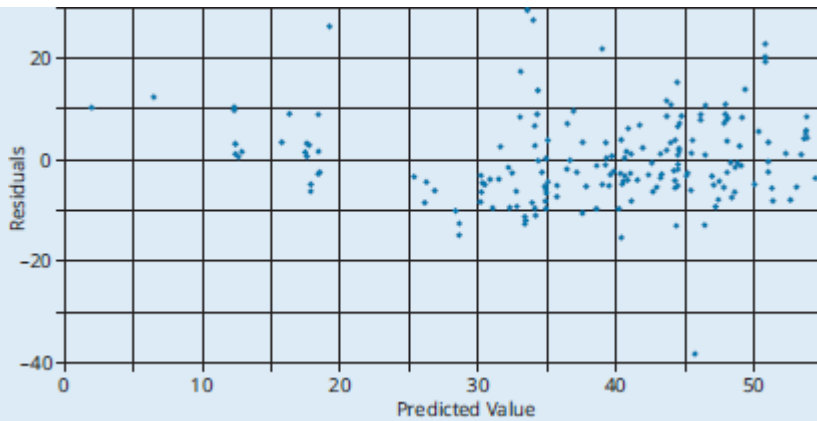

Exhibit 2: Plots of the Residuals vs. the Independent Variables

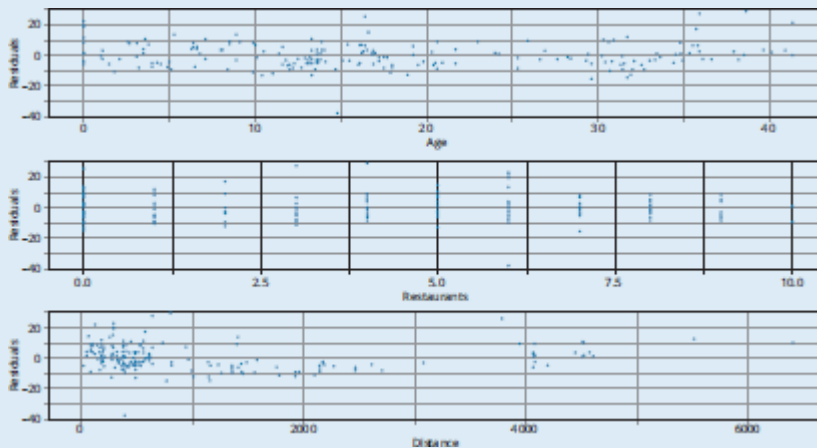
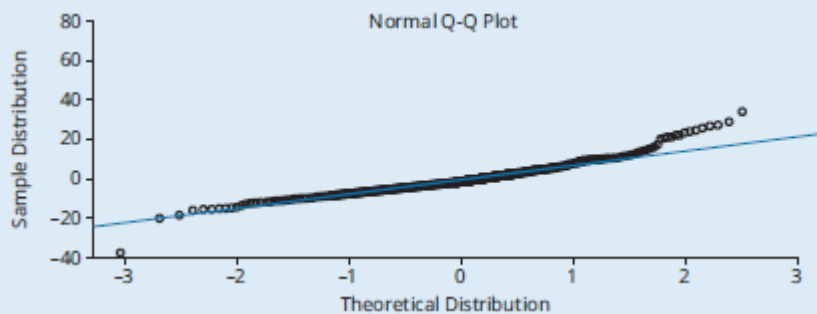

Exhibit 3: Normal Q-Q Plot of Residuals



1. Interpret the plot of regression residuals versus the predicted value of the dependent variable as shown in Exhibit 1.
2. Interpret the plot of regression residuals versus the independent variables as shown in Exhibit 2.
3. Interpret the Normal Q-Q plot of regression residuals as shown in Exhibit 3.

Answer:

1. Exhibit 1 does not indicate a systematic pattern or directional relationship between the predicted value of the dependent variable and the model residuals as indicated by the horizontal line centered on 0. This conforms to the requirement that residuals are independent of the predicted value of the dependent variable. Visually, it appears that the residuals have a constant variance and are uncorrelated with each other.

2. Exhibit 2 does not indicate a directional relationship between the residuals and any of the independent variables. The residuals are scattered around the horizontal line 0 across different values of the independent variables. This is desirable as it conforms to the requirement that the residuals are unrelated to the independent variables.
3. For a standard normal distribution, only 5% of the observations should be beyond -1.65 standard deviations of 0. We see that a few observations are beyond -2 standard deviations in Exhibit 3, with one outlier beyond -3 standard deviations. Similarly, it appears that there are a higher-than-expected number of observations beyond $+2$ standard deviations. Exhibit 3 also shows skewness in the right tail where the observations are skewed above the line of theoretical distribution. In summary, the distribution of the residuals deviates from a normal distribution as it has fatter tails and right skewness.



MODULE QUIZ 1.1

1. Which of the following investment problems is *least likely* to be addressed by using a multiple regression model?
 - A. Prediction of the likelihood of monetary tightening by the central bank using macroeconomic variables.
 - B. Uncovering a systematic pattern in the value of a currency using historical daily price data for that currency.
 - C. Determining if the five-factor Fama-French model can be improved by adding an earnings momentum factor.
2. A multiple regression model with two explanatory variables was fitted as follows: $Y = 2.30 + 5.02 X_1 - 4.55 X_2$. Which of the following is the *least appropriate* interpretation of this model?
 - A. The forecasted value of Y is 2.30 when both X_1 and X_2 are equal to zero.
 - B. A 1% increase in X_1 would lead to a 7.32% increase in Y.
 - C. A 1% increase in X_2 would lead to a 4.55% decrease in Y.
3. Which of the following *least accurately* represents an assumption of the multiple regression model?
 - A. The relationship between the X variables is linear.
 - B. The variance of the error is constant.
 - C. The residual distribution is normal.

MODULE 1.2: EVALUATING REGRESSION MODEL FIT AND INTERPRETING MODEL RESULTS



Video covering this content is available online.

LOS 1.d: Evaluate how well a multiple regression model explains the dependent variable by analyzing ANOVA table results and measures of goodness of fit.

ANOVA Tables

By decomposing the total variation in the dependent variable into the explained and unexplained components, we can evaluate the quality of model fit. **Analysis of variance (ANOVA)** is a statistical procedure that provides this information.

The results of the ANOVA procedure are presented in an ANOVA table, which accompanies a multiple regression output. A generic ANOVA table is presented in Figure 1.2.

Figure 1.2: ANOVA Table

Source	df (Degrees of Freedom)	SS (Sum of Squares)	MS (Mean Square = SS/df)
Regression	k	RSS	MSR
Error	n - k - 1	SSE	MSE
Total	n - 1	SST	

The first column indicates the “source” of the variation: regression is the explained component of the variation, while error is the unexplained component.

Coefficient of Determination, R^2

R^2 evaluates the overall effectiveness of the entire set of independent variables in explaining the dependent variable. It is the percentage of variation in the dependent variable that is *collectively* explained by all of the independent variables. For example, an R^2 of 0.63 indicates that the model, as a whole, explains 63% of the variation in the dependent variable.

$$R^2 = \frac{\text{total variation} - \text{unexplained variation}}{\text{total variation}}$$

$$= \frac{SST - SSE}{SST} = \frac{\text{explained variation}}{\text{total variation}} = \frac{RSS}{SST}$$

Adjusted R^2

Unfortunately, R^2 almost always increases as more independent variables are added to the model—even if the marginal contribution of the new variables is not statistically significant. Consequently, a relatively high R^2 may reflect the impact of a large set of independent variables, rather than how efficiently the set explains the dependent variable. This problem is often referred to as overestimating or **overfitting** the regression model.

To overcome the problem of overfitting (the impact of additional variables on the explanatory power of a regression model), many researchers recommend adjusting R^2 for the number of independent variables. The *adjusted R^2* value is expressed as:

$$R_a^2 = 1 - \left[\left(\frac{n-1}{n-k-1} \right) \times (1 - R^2) \right]$$

where:

n = number of observations

k = number of independent variables

R_a^2 = adjusted R^2

R_a^2 will always be less than or equal to R^2 . So while adding a new independent variable to the model will increase R^2 , it may either increase *or decrease* the R_a^2 . If the new variable has only a small effect on R^2 (i.e., the absolute value of the coefficient’s t-statistic is less than 1), the value of R_a^2 will decrease.

EXAMPLE: Calculating R^2 and adjusted R^2

An analyst runs a regression of monthly stock returns on five independent variables over 60 months. The total sum of squares for the regression is 460, and the sum of squared errors is 170. Calculate the R^2 and adjusted R^2 .

Answer:

$$R^2 = \frac{460 - 170}{460} = 0.630 = 63.0\%$$

$$R_a^2 = 1 - \left[\left(\frac{60 - 1}{60 - 5 - 1} \right) \times (1 - 0.63) \right] = 0.596 = 59.6\%$$

The R^2 of 63% suggests that the five independent variables together explain 63% of the variation in monthly stock returns. The R_a^2 is, as expected, a somewhat lower value.

EXAMPLE: Interpreting adjusted R^2

Suppose the analyst now adds four more independent variables to the regression, and the R^2 increases to 65.0%. Identify which model the analyst is most likely to prefer.

Answer:

With nine independent variables, even though the R^2 has increased from 63% to 65%, the adjusted R^2 has decreased from 59.6% to 58.7%:

$$R_a^2 = 1 - \left[\left(\frac{60 - 1}{60 - 9 - 1} \right) \times (1 - 0.65) \right] = 0.587 = 58.7\%$$

The analyst will prefer the first model because the adjusted R^2 is higher, and the model has five independent variables as opposed to nine.

While the adjusted R^2 penalizes overfitting, it does not indicate the quality of model fit, nor does it indicate statistical significance of the slope coefficients. We can formally evaluate the overall model fit using an F -test (discussed later).

For evaluating a regression model, regression output may include the Akaike's information criterion (AIC) and the Schwarz's Bayesian information criteria (BIC). Both AIC and BIC evaluate the quality of model fit *among competing models for the same dependent variable*. Lower values indicate a better model under either criteria.

AIC is used if the goal is to have a better forecast, while BIC is used if the goal is a better goodness of fit.

These metrics can be calculated as follows:

$$AIC = n \times \ln\left(\frac{SSE}{n}\right) + 2(k + 1)$$

$$BIC = n \times \ln\left(\frac{SSE}{n}\right) + \ln(n) \times (k + 1)$$

where:

k = number of independent variables

The variable k is a penalty parameter in both criteria: higher values of k result in higher values of the criteria. Because $\ln(n)$ is greater than 2 for even small sample sizes, the BIC metric imposes a higher penalty for overfitting.

EXAMPLE: Goodness of fit for the rent model

Continuing our example on rental price per square foot, the following shows the results when a single factor, two factors, and all three factors are used in the model.

Independent Variable(s)	K	SSR	SSE	R ²	R ² -Adj	AIC	BIC
Age	1	3,318.9	32,627.3	9.23%	8.75%	985.9	992.4
Age + Distance	2	20,946.1	15,000.2	58.27%	57.8%	839.4	849.2
Age + Distance + Restaurants	3	22,395.6	13,550.5	62.30%	61.7%	822.0	835.0

- Which model is the most appropriate for use in generating forecasts?
- Which model has a better goodness of fit?

Answer:

- The model with all three independent variables has the lowest AIC, and hence is the most appropriate model for generating forecasts.
- The model with all three independent variables has the lowest BIC and hence the best goodness of fit. Also, the adjusted R² for the three-factor model is the highest of the three models.

LOS 1.e: Formulate hypotheses on the significance of two or more coefficients in a multiple regression model and interpret the results of the joint hypothesis tests.

In addition to AIC and BIC, we can use a formal F -test to evaluate **nested models**. Nested models are models such that one model, called the **full model** or **unrestricted model**, has a higher number of independent variables while another model, called the **restricted model**, has only a subset of the independent variables. Consider a full model with three independent variables that is evaluated relative to a more parsimonious restricted model, which includes only the first variable as the independent variable.

$$\text{Unrestricted model: } Y_i = b_0 + b_1 X_1 + b_2 X_2 + b_3 X_3 + \epsilon_i$$

$$\text{Restricted model: } Y_i = b_0 + b_1 X_1 + \epsilon_i$$

We want to test the following hypothesis:

$$H_0: b_2 = b_3 = 0. \text{ vs. } H_a: b_2 \text{ or } b_3 \neq 0$$

We calculate the F -statistic to test this hypothesis as:

$$F = \frac{(SSE_R - SSE_U)/q}{(SSE_U)/(n - k - 1)} \text{ with } q \text{ and } (n - k - 1) \text{ degrees of freedom}$$

where:

R and U represent the restricted and unrestricted models, respectively

q = number of excluded variables in the restricted model

k = independent variables in the full model

Decision rule: reject H_0 if F (test-statistic) > F_c (critical value)

The F -test evaluates whether the relative decrease in SSE due to the inclusion of q additional variables is statistically justified.

We could evaluate the individual slope coefficients using t -tests. However, because there is likely to be some amount of correlation among the independent variables, the joint significance of excluded variables F -test provides a more meaningful evaluation of the explanatory power of alternative models.

EXAMPLE: Joint hypothesis test

Continuing our previous rental model data, and using the following information, conduct a joint test of hypotheses for the slope coefficients 2 and 3 at a 5% level of significance.

Model	k	SSE	n
Unrestricted	3	13,550.64	191
Restricted	1	32,627.29	191

Partial F-table (5% level of significance)

Denominator degrees of freedom	Numerator degrees of freedom		
	1	2	3
1	161	200	216
30	4.17	3.32	2.92
60	4.00	3.15	2.76
120	3.92	3.07	2.68
190	3.89	3.04	2.65
∞	3.84	3.00	2.60

Answer:

$$F = \frac{(SSE_R - SSE_U)/q}{(SSE_U)/(n - k - 1)} = \frac{(32,627.29 - 13,550.64)/2}{(13,550.64)/(191 - 3 - 1)} = 131.63$$

The critical F -value with 2 and 187 degrees of freedom is 3.04, so we reject the null hypothesis and conclude that at least one of the two slope coefficients of the excluded variables is statistically different from 0.



PROFESSOR'S NOTE

When testing the hypothesis that all the regression coefficients are simultaneously equal to zero, the F -test is always a one-tailed test, despite the

fact that it looks like it should be a two-tailed test because there is an equal sign in the null hypothesis. This is a common source of confusion among Level II candidates; make sure you don't make that mistake on the exam.

As a general case, we can also use the F -test to evaluate the *overall* model fit. That is, the F -statistic can be used to test whether *at least one* of the independent variables explains a significant portion of the variation of the dependent variable.

For example, if there are three independent variables in the model, the hypothesis is structured as:

$$H_0: b_1 = b_2 = b_3 = 0 \text{ versus } H_a: \text{at least one } b_j \neq 0$$

In such a situation, all the explanatory variables are excluded in the restricted model (i.e., $q = k$), and all of the variation in the restricted model is unexplained (i.e., $SSE_R = SST_U$). The F -statistic then becomes:

$$F = \frac{(SSE_R - SSE_U)/q}{(SSE_U)/(n - k - 1)} = \frac{(SST_U - SSE_U)/k}{(SSE_U)/(n - k - 1)} = \frac{(RSS_U)/k}{(SSE_U)/(n - k - 1)}$$

LOS 1.f: Calculate and interpret a predicted value for the dependent variable, given the estimated regression model and assumed values for the independent variable.

Predicting the Dependent Variable

We can use the regression equation to make predictions about the dependent variable *based on forecasted values of the independent variables*. The process is similar to forecasting with simple linear regression, except now we need predicted values for more than one independent variable. The predicted value of dependent variable Y is:

$$\hat{Y}_i = \hat{b}_0 + \hat{b}_1 \hat{X}_{1i} + \hat{b}_2 \hat{X}_{2i} + \dots + \hat{b}_k \hat{X}_{ki}$$

where:

\hat{Y}_i = the predicted value of the dependent variable

\hat{b}_j = the estimated slope coefficient for the j th independent variable

\hat{X}_{ji} = the forecast of the j th independent variable, $j = 1, 2, \dots, k$

The prediction of the dependent variable uses the estimated intercept and all of the estimated slope coefficients, regardless of whether the estimated coefficients are statistically significantly different from zero. For example, suppose you estimate the following regression equation: $\hat{Y} = 6 + 2X_1 + 4X_2$ and you determine that only the first independent variable (X_1) is statistically significant (i.e., you fail to reject the null that $b_2 = 0$). To predict Y given forecasts of $X_1 = 0.6$ and $X_2 = 0.8$, you would use the *complete* model: $\hat{Y} = 6 + (2 \times 0.6) + (4 \times 0.8) = 10.4$. Alternatively, you could drop X_2 and *re-estimate* the model using just X_1 ; but remember that the coefficient of X_1 will most likely change.

EXAMPLE: Calculating a predicted value for the dependent variable

An analyst would like to use the estimated regression equation from the previous example to calculate the predicted 10-year real earnings growth rate for the S&P 500, assuming the payout ratio of the index is 50%. He observes that the slope of the yield

curve is currently 4%. What is the model's prediction for the index's real earnings growth rate?

Answer:

$$\widehat{EG10} = -11.6\% + 0.25(50\%) + 0.14(4\%) = 1.46\%$$

The model predicts a 1.46% real earnings growth rate for the S&P 500, assuming a 50% payout ratio, when the slope of the yield curve is 4%.



MODULE QUIZ 1.2

Use the following information to answer Questions 1 and 2.

An analyst evaluates the *sum of squared error* and *total sum of squares* from a multiple regression with four independent variables to be 4,320 and 9,105, respectively. A restricted model excluding the last two variables has the sum of squared errors of 5,105. There are 65 observations in the sample.

1. The F -statistic for testing $H_0: b_1 = b_2 = b_3 = b_4 = 0$ vs. H_a : at least one $b_j \neq 0$ is *closest* to:
 - A. 13.54.
 - B. 13.77.
 - C. 16.61.
2. The F -statistic for testing $H_0: b_3 = b_4 = 0$ vs. H_a : at least one of b_3 or $b_4 \neq 0$, is *closest* to:
 - A. 5.45.
 - B. 12.2.
 - C. 392.
3. The adjusted R^2 of the full model is *closest* to:
 - A. 0.50.
 - B. 0.53.
 - C. 0.67.
4. Which model is *most likely* to have the best goodness of fit?
 - A. The full model because it has a lower BIC.
 - B. The full model because it has a lower AIC.
 - C. The reduced model because it has a lower BIC.

MODULE 1.3: MODEL SPECIFICATION



Video covering this content is available online.

Warm-Up: Model Specification

Regression model specification is the selection of the explanatory (independent) variables to be included in a model, and the transformations (if any) of those explanatory variables.

For example: suppose that we're trying to predict a P/E ratio using a cross-sectional regression based on fundamental variables that are related to P/E. Valuation theory suggests that variables associated with P/E include: the stock's dividend payout ratio (DPO), growth rate (G), and beta (B).

LOS 1.g: Describe how model misspecification affects the results of a regression analysis

and how to avoid common forms of misspecification.

The principles of model specification require that the chosen independent variables have an economic rationale, that the model is parsimonious (i.e., simple and efficient), and that the regression's functional form is correctly specified. A properly specified model should also perform well outside the sample, and not violate key regression assumptions. Figure 1.3 summarizes different types of functional form misspecifications.

Figure 1.3: Functional Form Model Misspecifications

Misspecification	Description	Effect
Omission of important independent variable(s)	Based on economic theory, one or more variables that should have been included are omitted.	Biased and inconsistent regression parameters May lead to serial correlation or heteroskedasticity in the residuals
Inappropriate variable form	The relationship between the dependent and independent variables may be non-linear.	May lead to heteroskedasticity in the residuals
Inappropriate variable scaling	Variables may need to be transformed before estimating the regression.	May lead to heteroskedasticity in the residuals or multicollinearity
Data improperly pooled	Sample has periods of dissimilar economic environments (that should not be pooled).	May lead to heteroskedasticity or serial correlation in the residuals

Examples of Misspecification of Functional Form

Let's start with a regression in which we're trying to predict monthly returns on a portfolio of Chinese stocks (R) using four independent variables: portfolio beta (B), the natural log of market capitalization ($\ln M$), the natural log of the price-to-book ratio $\ln(PB)$, and free float (FF). Free float is equal to the ratio of shares available for trading by the investing public to total number of outstanding shares. The regression is estimated with 72 monthly observations from July 1996 to June 2002. The *correct* specification of the model is as follows:

$$R = b_0 + b_1\beta + b_2\ln M + b_3\ln PB + b_4FF + \epsilon$$



PROFESSOR'S NOTE

The correct regression model specification is based on a study by Wang and Xu (2004).² The incorrect specifications that follow are designed to illustrate examples of common misspecifications; they are not part of the Wang and Xu study.

Misspecification #1: Omitting a Variable

Suppose we do not include $\ln M$ in the regression model:

$$R = a_0 + a_1\beta + a_2\ln PB + a_3FF + \epsilon$$

If $\ln M$ is correlated with any of the remaining independent variables (β , $\ln PB$, or FF), then the error term is also correlated with the same independent variables, and the resulting

regression coefficients (the estimates of a_0 , a_1 , and a_2) will be biased and inconsistent. That means our hypothesis tests and predictions using the model will be unreliable.

If the omitted variable is uncorrelated with the other independent variables, then the error term will reflect the value of the missing variable's contribution, and the value of the intercept (a_0) will be biased (even though the estimates of a_1 and a_2 will be correct).



PROFESSOR'S NOTE

Omission of a variable in this context means that the variable *should be included* in the model but is not. Absence of a variable in the model does not necessarily imply omission. (While discussing multicollinearity, the solution was to drop one of the *highly* correlated variables. The omitted variable here is not *highly* correlated.)

Misspecification #2: Variable Should Be Transformed

Regression assumes that the dependent variable is linearly related to each of the independent variables. Initially, however, the relationship between the model inputs and output may be non-linear. For example, the relationship between market capitalization and portfolio returns is not linear; rather the *natural log* of market cap is linearly related to returns. If we include market cap in our regression without transforming it by taking the natural log—i.e., if we use M and not $\ln(M)$ —we've misspecified the model.

$$R = c_0 + c_1\beta + c_2M + c_3\ln PB + c_4FF + \epsilon$$

Misspecification #3: Inappropriate Scaling of the Variable

If financial statement data are included in the regression model, a common transformation is to standardize the variables by dividing by sales (for income statement or cash flow items) or total assets (for balance sheet items). You should recognize these as items from *common-size financial statements*. Examples of other scaling transformations include squaring the variable or taking the square root of the variable.

Suppose that rather than defining FF as the *proportion* of shares available to be traded, we instead use the *number* of shares available to be traded. In such a case, we could have similar companies with very different values for FF ; an example of inappropriate scaling.

Misspecification #4: Incorrectly Pooling Data

Suppose the relationship between returns and the independent variables during the first three years is actually different than the relationship in the second 3-year period (i.e., the regression coefficients are different from one time period to the next). By pooling the data and estimating one regression over the entire 6-year period, rather than estimating separate regressions over each of the two subperiods, we have misspecified the model. Our hypothesis tests and predictions of portfolio returns will be misleading.

Warm-Up: Violation of Regression Assumptions

Regression analysis relies on the assumptions listed earlier. When these assumptions are violated, the inferences drawn from the model are questionable. There are three primary

assumption violations that you will encounter: (1) heteroskedasticity, (2) serial correlation (i.e., autocorrelation), and (3) multicollinearity.

On exam day, you want to be able to answer the following four questions about each of the three assumption violations:

- What is it?
- What is its effect on regression analysis?
- How do we detect it?
- How do we correct for it?

LOS 1.h: Explain the types of heteroskedasticity and how it affects statistical inference.

What Is Heteroskedasticity?

Recall that one of the assumptions of multiple regression is that the variance of the residuals is constant across observations. **Heteroskedasticity** occurs when the variance of the residuals is not the same across all observations in the sample. This happens when there are subsamples that are more spread out than the rest of the sample.

Unconditional heteroskedasticity occurs when the heteroskedasticity is not related to the level of the independent variables, which means that it doesn't systematically increase or decrease with changes in the value of the independent variable(s). While this is a violation of the equal variance assumption, *it usually causes no major problems with the regression.*

Conditional heteroskedasticity is heteroskedasticity that is related to (i.e., conditional on) the level of the independent variables. For example, conditional heteroskedasticity exists if the variance of the residual term increases as the value of the independent variable increases, as shown in Figure 1.4. (Notice that in this figure the residual variance associated with the larger values of the independent variable, X , is larger than the residual variance associated with the smaller values of X .) Conditional heteroskedasticity *does create significant problems for statistical inference.*

Figure 1.4: Conditional Heteroskedasticity

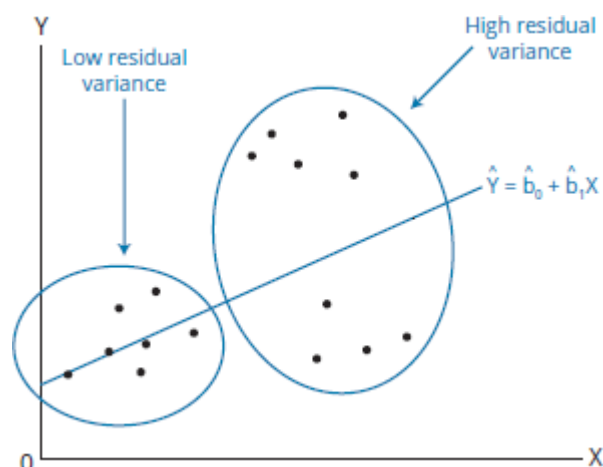

Effect of Conditional Heteroskedasticity on Regression Analysis

There are two effects of conditional heteroskedasticity that you should be aware of:

- The standard errors are usually unreliable estimates. (For financial data, these standard errors are usually *underestimated*, resulting in Type I errors.)
- The *F*-test for the overall model is also unreliable.
- Coefficient estimates are still consistent and unbiased.

Detecting Conditional Heteroskedasticity

There are two methods to detect conditional heteroskedasticity: by examining scatter plots of the residuals and by using the Breusch-Pagan chi-square (χ^2) test. A scatter plot of the residuals versus one or more of the independent variables can reveal patterns among observations.

EXAMPLE: Detecting conditional heteroskedasticity with a residual plot

You have been studying five years of monthly returns for a particular mutual fund, hoping to draw conclusions about the fund's average performance. You calculate the mean return, the standard deviation, and the fund's beta by regressing the fund's returns on S&P 500 index returns (the independent variable). The standard deviation of returns and the fund's beta don't seem to fit the firm's stated risk profile. For your analysis, you have prepared a scatter plot of the error terms (actual return minus predicted return) for the regression using the five years of returns, as shown next. Determine whether the residual plot indicates that there may be a problem with the data.

Residual Plot

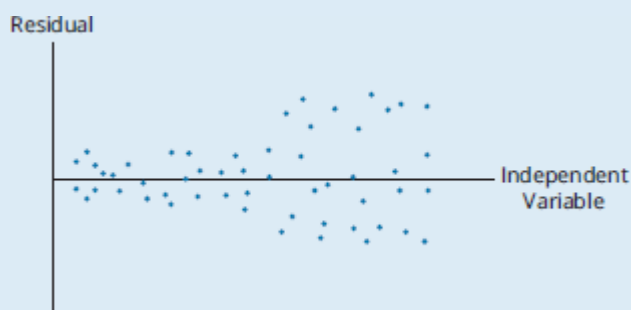

Answer:

The residual plot indicates the presence of conditional heteroskedasticity. Notice how the variation in the regression residuals increases as the independent variable increases: this indicates that the variance of the fund's returns about the mean is related to the level of the independent variable.

More formally, we can use the **Breusch-Pagan (BP) test** to detect conditional heteroskedasticity. The BP test calls for the squared residuals (as the dependent variable) to be regressed on the original set of independent variables. If conditional

heteroskedasticity is present, the independent variables will significantly contribute to the explanation of the variability in the squared residuals. The test statistic for the Breusch-Pagan test, which has a chi-square (χ^2) distribution, is calculated as:

$$\text{BP chi-square test statistic} = n \times R_{\text{resid}}^2 \text{ with } k \text{ degrees of freedom}$$

where:

n = the number of observations

R_{resid}^2 = R^2 from a second regression (of the squared residuals from the first regression) on the independent variables

k = the number of independent variables

This is a one-tailed test, because heteroskedasticity is only a problem if the R^2 and the BP test statistic are too large.

EXAMPLE: The Breusch-Pagan test

Suppose that the residual plot of mutual fund returns over time shows evidence of heteroskedasticity. To confirm our suspicions, we regress the squared residuals from the original regression on the independent variable, the S&P 500 index returns. The R^2 from that regression is 8%. How would we use the Breusch-Pagan test to determine whether heteroskedasticity is present at the 5% significance level?

Answer:

With five years of monthly observations, n is equal to 60. The test statistic is:

$$n \times R^2 = 60 \times 0.08 = 4.8$$

The one-tailed critical value for a chi-square distribution with one degree of freedom and α of 5% is 3.841. Therefore, we should reject the null hypothesis and conclude that we have a problem with conditional heteroskedasticity.

Correcting Heteroskedasticity

To correct for conditional heteroskedasticity of regression residuals, we can calculate **robust standard errors** (also called **White-corrected standard errors** or **heteroskedasticity-consistent standard errors**). These robust standard errors are then used to recalculate the t -statistics using the original regression coefficients for hypothesis testing.

LOS 1.i: Explain serial correlation and how it affects statistical inference.

Serial correlation, also known as **autocorrelation**, refers to a situation in which regression residual terms are correlated with one another; that is, not independent. Serial correlation can pose serious problem with regressions using time series data.

Positive serial correlation exists when a positive residual in one time period increases the probability of observing a *positive* residual in the next time period.

Negative serial correlation occurs when a positive residual in one period increases the probability of observing a *negative* residual in the next period.

Effect of Serial Correlation on Model Parameters

Consider a model that employs a lagged value of the dependent variable as one of the independent variables. Residual autocorrelation in such a model causes the estimates of the slope coefficients to be inconsistent. If the model does not have any lagged dependent variables, then the estimates of the slope coefficient will be consistent.

Effect on Standard Errors

Positive first-order serial correlation in residuals is most common in financial time series data. Positive serial correlation typically results in coefficient standard errors that are too small, causing the computed t -statistics (and F -statistic) to be larger than they should be, which will lead to Type I errors.



PROFESSOR'S NOTE

Serial correlation observed in financial data (not residuals, which is our discussion here) indicates a pattern that can be modeled. This idea is covered in our reading on time series analysis.

Detecting Serial Correlation

Residual serial correlation at a *single lag* can be detected using the **Durbin-Watson (DW) statistic**. A more general test (which can accommodate serial correlation at multiple lags) is the **Breusch-Godfrey (BG) test**. The BG test regresses the regression residuals against the original set of independent variables, plus one or more additional variables representing lagged residual(s):

$$\hat{\epsilon}_t = b_0 + a_1 X_{1t} + a_2 X_{2t} + \dots + a_k X_{kt} + p_1 \epsilon_{t-1} + p_2 \epsilon_{t-2}$$

We then test whether each of the slope coefficients of the lagged residuals is statistically significantly different from 0.

$$H_0: p_1 = 0 \text{ vs. } H_a: p_1 \neq 0$$

The BG test statistic has an F -distribution with p and $n - p - k - 1$ degrees of freedom, where p = the number of lags tested. Most software packages provide the BG test statistic. If the BG test statistic > critical value, we reject the null hypothesis of no serial correlation.

Correction for Serial Correlation

To correct for serial correlation in regression residuals, we can calculate **robust standard errors** (also called **Newey-West corrected standard errors** or **heteroskedasticity-consistent standard errors**). These robust standard errors are then used to recalculate the t -statistics using the original regression coefficients.

LOS 1.j: Explain multicollinearity and how it affects regression analysis.

Multicollinearity refers to the condition when two or more of the independent variables, (or linear combinations of three or more independent variables), in a multiple regression are highly correlated with each other. This condition inflates standard errors and lowers t -stats.

Effect of Multicollinearity on Model Parameters

Multicollinearity does not affect the consistency of slope coefficients, but makes those estimates *imprecise and unreliable*.

Effect on Standard Errors

Standard errors are too high because we cannot assign precise credit for explaining the variation in the dependent variable to the independent variables. This leads to Type II errors.

Detection

The most common sign of multicollinearity is when *t*-tests indicate that none of the individual coefficients are significantly different than zero, but the *F*-test indicates that at least one of the coefficients is statistically significant, and the R^2 is high. This suggests that the variables together explain much of the variation in the dependent variable, but the individual independent variables don't. This can happen when the independent variables are highly correlated with each other—so while their common source of variation is explaining the dependent variable, the high degree of correlation also “washes out” the individual effects.

More formally, we can quantify multicollinearity using the **variance inflation factor (VIF)** for each of the independent variables. We start by regressing one of the independent variable “*j*” against the remaining independent variables. The R_j^2 from that equation is then used to calculate the VIF of that variable.

$$VIF_j = 1 / (1 - R_j^2)$$

High values of R_j^2 signal that the variable is well explained by other variables, and indicates that the variable will have a high VIF. A VIF_j value of 1 (i.e., $R^2 = 0$) indicates that the variable *j* is not highly correlated with other independent variables. VIF values greater than 5 (i.e., $R^2 > 80\%$) warrant further investigation, while values above 10 (i.e., $R^2 > 90\%$) indicates severe multicollinearity.

Correction

The most common method to correct for multicollinearity is to omit one or more of the correlated independent variables. Alternatively, we can use a different proxy for one of the included independent variables, or increase the sample size.



MODULE QUIZ 1.3

Use the following information to answer Questions 1 through 6.

A multiple regression model was used to explain stock returns based on the following variables:

Dependent variable:

RET = annual stock returns (%)

Independent variables:

MKT = market capitalization in millions = market capitalization / \$1.0 million

IND = Industry quartile ranking (IND = 4 is the highest ranking)

FORT = Fortune 500 firm (where $FORT = 1$ if the stock is that of a Fortune 500 firm, $FORT = 0$ if not a Fortune 500 stock)

The regression results are presented in the following tables.

	Coefficient	Standard Error	t-Statistic	p-Value
Intercept	0.5220	1.2100	0.430	0.681
Market Capitalization	0.0460	0.0150	3.090	0.021
Industry Ranking	0.7102	0.2725	2.610	0.040
Fortune 500	0.9000	0.5281	1.700	0.139

ANOVA	df	SS	MSS	F	Significance F
Regression	3	20.5969	6.8656	12.100	0.006
Error	6	3.4031	0.5672		
Total	9	24.0000			

Test	Test-Statistic
Breusch-Pagan	17.7
Durbin-Watson	1.8

- Based on the results in the table, which of the following *most accurately* represents the regression equation for annual stock percentage returns?
 - $1.21 + 0.0150(\text{MKT}) + 0.2725(\text{IND}) + 0.5281(\text{FORT})$.
 - $0.5220(\text{INT}) + 0.0460(\text{MKT}) + 0.7102(\text{IND}) + 0.9000(\text{FORT})$.
 - $0.0460(\text{MKT}) + 0.7102(\text{IND}) + 0.9(\text{FORT}) + 0.522$.
- Relative to a non-Fortune 500 company, the expected extra annual percentage stock return attributable to being a Fortune 500 stock is *closest* to:
 - 0.522.
 - 0.139.
 - 0.900.
- The expected return on the stock of a firm that is not in the Fortune 500, that has a market capitalization of \$5 million, and that is in an industry with a rank of 3, will be *closest* to:
 - 2.88%.
 - 3.98%.
 - 5.08%.
- Does being a Fortune 500 stock contribute significantly to stock returns?
 - Yes, at a 10% level of significance.
 - Yes, at a 5% level of significance.

- C. No, at a 10% level of significance.
5. The p -value of the Breusch-Pagan test is 0.0005. Based on this data and the information in the tables, there is evidence of:
- serial correlation only.
 - serial correlation and heteroskedasticity.
 - heteroskedasticity only.
6. Which of the following situations is *least likely* to result in the misspecification of a regression model that uses monthly returns as the dependent variable?
- Failing to include an independent variable that is related to monthly returns.
 - Using leading P/E from the previous period as an independent variable.
 - Using actual inflation as an independent variable as a proxy for expected inflation.

MODULE 1.4: EXTENSIONS OF MULTIPLE REGRESSION



Video covering this content is available online.

LOS 1.k: Describe influence analysis and methods of detecting influential data points.

Outliers are extreme observations of the dependent (or ‘Y’) variable, while **high-leverage points** are the extreme observations of the independent (or ‘X’) variables.

A high-leverage point would be identified using a measure called leverage (L_{ij}) which can be provided by statistical packages. Leverage is a measure of the distance between the j th observation of independent variable i relative to its sample mean. Leverage takes a value between 0 and 1. The higher the value of leverage, the greater the distance—and hence the higher the potential influence of the observation—on the estimated regression parameters.

The sum of the individual leverages for all observations is $k + 1$. If a variable’s leverage is higher than three times the average, $[3(k + 1) / n]$, it is considered potentially influential.

We can identify outliers using the **studentized residuals**. The following steps outline the procedure:

- Estimate the regression model using the original sample of size n . Delete one observation and re-estimate the regression using $(n - 1)$ observations. Perform this sequentially, for all observations, deleting one observation at a time.
- Compare the actual Y value of the deleted observation i to the predicted Y -values using the model parameters estimated with that observation deleted.

$$e_i^* = Y_i - \hat{Y}_i^*$$

- The studentized residual is the residual in Step 2 divided by its standard deviation.

$$t_i^* = \frac{e_i^*}{s_e^*}$$

- We can then compare this studentized residual to critical values from a t -distribution with $n - k - 2$ degrees of freedom (because we now only have $n - 1$ observations), to determine if the observation is influential.



PROFESSOR'S NOTE

Candidates should focus on the *interpretation* of studentized residuals (provided by most software packages) rather than on calculating them.

Not all outliers or high-leverage points are influential. **Influential** data points are extreme observations that, when excluded, cause a significant change to model coefficients.

Once influential observations are identified, we need to determine whether this was the result of an input error (in which case, the error should be rectified or the observation deleted), or if the observation is valid but the model is incomplete (i.e., important independent variables are omitted). Analysts can also winsorize the dataset to minimize the impact of outliers.

EXAMPLE: Detecting outliers

A researcher is examining a regression model predicting the initial 3-day return on IPOs using three explanatory variables. The training sample consists of 24 IPOs from the past two years. The following exhibit shows the studentized residuals for each of the observations.

Observation	Studentized Residual
1	-0.0127
2	0.1890
3	2.2310
4	1.1080
5	-0.018
6	-1.6730
7	0.0542
8	-0.0127
9	-0.1753
10	1.1890
11	1.0540
12	-0.9130
13	0.0545
14	-0.0927
15	-1.8730
16	0.0742
17	-1.0963
18	0.1540
19	-3.0165
20	1.0542
21	-0.5440
22	-0.7210
23	2.1860
24	1.8140

Question:

Which observations are considered outliers using a 5% level of significance?

Answer:

We are given that: $n = 24$, $k = 3$, $\text{dof} = n - k - 2 = 19$. $t(0.05, 19, 2\text{-tailed}) = 2.09$. Observations 3, 19, and 23 have absolute values of studentized residuals exceeding 2.09, and thus are considered outliers.

LOS 1.1: Formulate and interpret a multiple regression model that includes qualitative independent variables.

Observations for most independent variables (e.g., firm size, level of GDP, interest rates, etc.) can take on a wide range of values. However, there are occasions when the independent variable is binary in nature—it is either “on” or “off” (or true/false). Independent variables that fall into this category are called **dummy variables** and are often used to quantify the impact of *qualitative* events.

Dummy variables are assigned a value of “0” or “1.” For example, in a time series regression of monthly stock returns, we could employ a “January” dummy variable that would take on the value of “1” if a stock return occurred in January, and “0” if it occurred in any other month. The purpose of including the January dummy variable would be to see if stock returns in January were significantly different than stock returns in all other months of the year. Many “January effect” anomaly studies employ this type of regression methodology.

The estimated regression coefficient for dummy variables indicates the difference in the dependent variable for the category represented by the dummy variable relative to the average value of the dependent variable for all classes except the dummy variable class. For example, testing the slope coefficient for the January dummy variable would indicate whether, and by how much, security returns are different in January versus the other months.

An important consideration when performing multiple regression with dummy variables is the choice of the *number* of dummy variables to include in the model. In the prior example, we had two classes: one set representing the data points that occurred during the month of January, and the other representing the rest of the year. When we want to distinguish between n classes, we must use $(n - 1)$ dummy variables. Otherwise, we would violate the regression assumption of no exact linear relationship between independent variables.

A dummy variable can be an **intercept dummy**, a **slope dummy**, or a combination of the two.

Consider a regression with one continuous X variable and one dummy variable (an intercept dummy):

$$Y = b_0 + d_0D + b_1X + \varepsilon$$

This regression becomes:

$$Y = b_0 + b_1X + \varepsilon \quad (\text{if } D = 0)$$

$$Y = (b_0 + d_0) + b_1X + \varepsilon \quad (\text{if } D = 1)$$

In other words, the intercept of the line shifts from b_0 to $(b_0 + d_0)$ if $D = 1$. The value of this shift (d_0) can be positive or negative.

A slope dummy, on the other hand, changes the slope of the regression equation:

$$Y = b_0 + b_1X + d_1(D \times X) + \varepsilon$$

And the regression then becomes:

$$Y = b_0 + b_1X + \varepsilon \quad (\text{if } D = 0)$$

$$Y = b_0 + (b_1 + d_1)X + \varepsilon \quad (\text{if } D = 1)$$

A slope dummy is the interaction term; it captures the interaction between the dummy variable and the continuous variable.

Finally, we could have dummies in both intercept and slope:

$$Y = b_0 + d_0D + b_1X + d_1(D \times X) + \varepsilon$$

which becomes:

$$Y = b_0 + b_1X + \varepsilon \quad (\text{if } D = 0)$$

$$Y = (b_0 + d_0) + (b_1 + d_1)X + \varepsilon \quad (\text{if } D = 1)$$

Interpreting the Coefficients in a Dummy Variable Regression

Consider the following regression equation for explaining quarterly EPS in terms of the calendar quarter of their occurrence:

$$EPS_t = b_0 + b_1Q_{1t} + b_2Q_{2t} + b_3Q_{3t} + \varepsilon_t$$

where:

EPS_t = a quarterly observation of earnings per share

Q_{1t} = 1 if period t is the first quarter, and $Q_{1t} = 0$ otherwise

Q_{2t} = 1 if period t is the second quarter, and $Q_{2t} = 0$ otherwise

Q_{3t} = 1 if period t is the third quarter, and $Q_{3t} = 0$ otherwise

In this equation, the intercept term, b_0 , represents the average value of EPS for the fourth quarter. The slope coefficient on each dummy variable estimates the *difference* in earnings per share (on average) between the respective quarter (i.e., quarter 1, 2, or 3) and the omitted quarter (the fourth quarter in this case). *Think of the omitted class as the reference point.*

For example, suppose we estimate the quarterly EPS regression model with 10 years of data (i.e., 40 quarterly observations) and find that $b_0 = 1.25$, $b_1 = 0.75$, $b_2 = -0.20$, and $b_3 = 0.10$:

$$\widehat{EPS}_t = 1.25 + 0.75Q_{1t} - 0.20Q_{2t} + 0.10Q_{3t}$$

We can use the equation to determine the average EPS in each quarter over the past 10 years:

$$\text{average fourth quarter EPS} = 1.25$$

$$\text{average first quarter EPS} = 1.25 + 0.75 = 2.00$$

$$\text{average second quarter EPS} = 1.25 - 0.20 = 1.05$$

$$\text{average third quarter EPS} = 1.25 + 0.10 = 1.35$$

These are also the model's predictions of future EPS in each quarter of the following year. For example, to use the model to predict EPS in the first quarter of the next year, set $\bar{Q}_1 = 1$, $\bar{Q}_2 = 0$, and $\bar{Q}_3 = 0$. Then:

$\widehat{\text{EPS}}_{Q_1} = 1.25 + 0.75(1) - 0.20(0) + 0.10(0) = 2.00$. This simple model uses average EPS for any specific quarter over the past 10 years as the forecast of EPS in its respective quarter of the following year.

LOS 1.m: Formulate and interpret a logistic regression model.

Financial analysis often calls for the use of a model that has a **qualitative dependent variable**—a categorical variable, usually a binary variable, which takes on a value of either zero or one. An example of an application requiring the use of a qualitative dependent variable is a model that attempts to estimate the probability of default for a bond issuer. In this case, the dependent variable may take on a value of one in the event of default and zero in the event of no default.

An ordinary regression model is not appropriate for situations that require a qualitative dependent variable, because the forecasted values of y using the model can be less than 0 or greater than 1, which are illogical values for probability. Instead, we transform the probability values of the dependent variable into odds: $p / (1 - p)$. For example, if probability = 0.80, then odds = 0.80 / 0.20 or 4 to 1. A logistic transformation involves taking the natural log of the odds: $\ln[p / (1 - p)]$.

Logistic regression (logit) models use log odds as the dependent variable.

$$\ln\left(\frac{p}{1-p}\right) = b_0 + b_1X_1 + b_2X_2 + \dots + \varepsilon$$

A logit model assumes that residuals have a logistic distribution, which is similar to a normal distribution but with fatter tails. We use logit models to estimate the probability of a discrete outcome, such as the probability of default of a company, or the probability that a merger will occur.

The coefficients of the logit model are estimated using the **maximum likelihood estimation** methodology. The interpretation of the intercept term in a logit model is similar to its interpretation in multiple regression: it provides an estimate of log odds when the values of all independent variables is zero. The interpretation of the slope coefficient is, however, not straightforward. Because the logistic regression model is nonlinear, the change in log odds when one of the independent variables changes is dependent on the curvature of the function at that point. To interpret the slope coefficient, we would typically start with the average values of the independent variables, estimate log odds, then change the value of one of the independent variables by 1 unit, and calculate the change in log odds.

Once the coefficients are estimated, using the regression equation, the predicted value of y (i.e., \hat{y}) can be calculated from the values of the X variables. The odds are then calculated as:

$$\text{odds} = e^{\hat{y}}$$

And the probability of the event is calculated as:

$$P = \text{odds} / (1 + \text{odds}) = 1 / (1 + e^{-\hat{y}})$$

EXAMPLE: Logistic regression

An analyst wants to estimate the likelihood of a dividend increase for the 36 companies that she is following. She collects historical data for three variables: age (number of years since the last increase), FCFE divided by market cap, and cash balance to total assets.

The regression output is shown here:

	Average Value	Coefficient	P-Value
Intercept	–	–3.445	0.002
Age	3.2	0.332	0.412
FCFE/MCap	0.08	12.33	0.016
Cash/TA	0.03	3.21	0.044

1. Interpret the intercept term.
2. Interpret the coefficients of the independent variables.

Answers:

1. The intercept term is statistically significant at a 1% level of significance (p -value < 0.01). Assuming all the independent variables have a value of zero, the odds of an increase in dividend is $e^{-3.445} = 0.0319$ and the probability of an increase in dividend = $0.0319 / (1 + 0.0319) = 0.0309$ or 3.09%.
2. Variable “age” is not statistically significant at 5% while the other two variables are (p -value < 0.05). At the average values of independent variables, the probability of a dividend increase is 21.42%. We calculate \hat{y} using average values of the independent variables:

Model:

$$y = -3.445 + 0.332 \text{ Age} + 12.33 \text{ FCFE/Mcap} + 3.21 \text{ Cash} = -3.445 + (0.332 \times 3.2) + (12.33 \times 0.08) + (3.21 \times 0.03) = -1.2999$$

$$\text{Then, probability} = 1 / (1 + e^{-\hat{y}}) = 0.21418 \text{ or } 21.42\%$$

Revised Model Input (increasing the value of FCFE/Mcap to 0.09):

$$y = -3.445 + 0.332 \text{ Age} + 12.33 \text{ FCFE/Mcap} + 3.21 \text{ Cash} = -3.445 + (0.332 \times 3.2) + (12.33 \times 0.09) + (3.21 \times 0.03) = -1.1766$$

$$\text{Then, probability} = 1 / (1 + e^{-\hat{y}}) = 1 / (1 + e^{1.1766}) = 0.235664 \text{ or } 23.57\%.$$

Change = 23.57% – 21.42% = 2.15%. Thus, an increase of 1 unit in FCFE/Mcap (i.e., from 0.08 to 0.09) leads to a probability increase of 2.15%. Similar computations for age and cash/TA yield probability increases of 6.11% and 0.54%, respectively.

Similar to the joint F -test to evaluate nested models, a **likelihood ratio (LR)** test is used for logistic regressions.

$$LR = -2 (\log \text{likelihood restricted model} - \log \text{likelihood unrestricted model})$$

Where the restricted model has “ q ” fewer independent variables.

The log-likelihood metric for a model always has a negative value. Higher values (closer to 0) indicate a better-fitting model.

The test statistic LR has a chi-square distribution with q degrees of freedom.

While traditional R^2 is not available for logit models, software packages often report pseudo- R^2 values. These pseudo- R^2 values should only be used to compare competing models using the same dependent variable.



MODULE QUIZ 1.4

Use the following information to answer Questions 1 through 5.

Phil Ohlmer estimates a cross-sectional regression in order to predict price to earnings ratios (P/E) from fundamental variables that are related to P/E, including dividend payout ratio (DPO), growth rate (G), and beta (B). All 50 stocks in the sample come from two industries, electric utilities and biotechnology. He defines the following dummy variable:

IND = 0 if the stock is in the electric utilities industry, or
 = 1 if the stock is in the biotechnology industry

The results of his regression are shown in the following table.

Variable	Coefficient	t-Statistic
Intercept	6.75	3.89*
IND	8.00	4.50*
DPO	4.00	1.86
G	12.35	2.43*
B	-0.50	1.46

*significant at the 5% level

While discussing the model with Bernie Shultz, Ohlmer mentions models with qualitative dependent variables. Ohlmer makes the following statements:

Statement 1: To evaluate nested models, a likelihood ratio (LR) test is used for logistic regressions. The LR test statistic uses an F -distribution.

Statement 2: The slope coefficients in a logit model are interpreted as the change in the probability of the event occurring per 1-unit change in the independent variable, holding all other independent variables constant.

Ohlmer also raises the topic of model parsimony. He notes that one of the models with five independent variables has a log-likelihood (LL) metric of -212.44 . Removing two of the independent variables results in LL (restricted) of -216.22 . He wants to use 5% level of significance (critical chi-square of 5.99).

- Based on these results, it would be *most appropriate* to conclude that:
 - biotechnology industry PEs are statistically significantly larger than electric utility industry PEs.

- B. electric utility PEs are statistically significantly larger than biotechnology industry PEs, holding DPO, G, and B constant.
- C. biotechnology industry PEs are statistically significantly larger than electric utility industry PEs, holding DPO, G, and B constant.
2. Ohlmer is valuing a biotechnology stock with a dividend payout ratio of 0.00, a beta of 1.50, and an expected earnings growth rate of 0.14. The predicted P/E on the basis of the values of the explanatory variables for the company is *closest* to:
- A. 7.7.
- B. 15.7.
- C. 17.2.
3. The *least likely* result of regression model misspecification is:
- A. unreliable hypothesis tests of the regression coefficients.
- B. inconsistent regression coefficients.
- C. unbiased regression coefficients.
4. Regarding Ohlmer's statements about qualitative dependent variables:
- A. only Statement 1 is correct.
- B. only Statement 2 is correct.
- C. both statements are incorrect.
5. At 5% level of significance, which of the following is the *most appropriate* conclusion for Ohlmer's restricted model?
- A. We can reject the null hypothesis that the excluded variables did not statistically significantly contribute to explaining the variation in the dependent variable.
- B. We fail to reject the null hypothesis that the excluded variables did not statistically significantly contribute to explaining the variation in the dependent variable.
- C. The restricted model has the same explanatory power as the unrestricted model.

KEY CONCEPTS

LOS 1.a

Multiple regression models can be used to identify relationships between variables, to forecast variables, or to test existing theories.

LOS 1.b

The general multiple linear regression model is:

$$Y_i = b_0 + b_1X_{1i} + b_2X_{2i} + \dots + b_kX_{ki} + \epsilon_i$$

The intercept term b_0 is the value of the dependent variable Y when all the independent variables (X) are equal to zero. The slope coefficient b_i is the estimated change in the dependent variable for a 1-unit change in variable i , holding all other independent variables constant.

LOS 1.c

Assumptions underlying a multiple regression model include:

- A linear relationship exists between the dependent and independent variables.
- The residuals are normally distributed.
- The variance of the error terms is constant for all observations.

- The residual for one observation is not correlated with that of another observation.
- The independent variables are not random, and there is no exact linear relation between any two or more independent variables.

LOS 1.d

An ANOVA table is used to assess the usefulness of a regression model's independent variable(s) in explaining the dependent variable:

Source	df (Degrees of Freedom)	SS (Sum of Squares)	MS Mean Square = (SS/df)
Regression	k	RSS	MSR
Error	n - k - 1	SSE	MSE
Total	n - 1	SST	

$$MSE = \frac{SSE}{n - k - 1}; MSR = \frac{RSS}{k}; R^2 = \frac{RSS}{SST}$$

Akaike's information criterion (AIC) and Schwarz's Bayesian information criteria (BIC) are used to evaluate competing models with the same dependent variable. AIC is used if the goal is a better forecast, while BIC is used if the goal is a better goodness of fit.

$$AIC = n \times \ln\left(\frac{SSE}{n}\right) + 2(k + 1)$$

$$BIC = n \times \ln\left(\frac{SSE}{n}\right) + \ln(n) \times (k + 1)$$

where:

k = the number of independent variables

LOS 1.e

Nested models comprise a full (or unrestricted) model, and a restricted model that uses "q" fewer independent variables. To test whether the "q" excluded variables add to the explanatory power of the models, we test the hypothesis:

$$H_0: b_1 = b_2 = \dots = b_q = 0. \text{ vs. } H_a: \text{at least one of the slope coefficients of excluded variables} \neq 0.$$

We calculate the F-statistic to test this hypothesis as:

$$F = \frac{(SSE_R - SSE_U)/q}{(SSE_U)/(n - k - 1)} \text{ with } q \text{ and } (n - k - 1) \text{ degrees of freedom}$$

where:

R and U represent the restricted and unrestricted models, respectively

q = number of excluded variables in the restricted model

k = independent variables in the full model

Decision rule: reject H_0 if $F(\text{test-statistic}) > F_c(\text{critical value})$

LOS 1.f

The value of dependent variable Y is predicted as:

$$\hat{Y} = \hat{b}_0 + \hat{b}_1 X_1 + \hat{b}_2 X_2 + \dots + \hat{b}_k X_k$$

LOS 1.g

Misspecification	Description	Effect
Omission of important independent variable(s)	One or more variables that should have been included have been omitted.	Biased and inconsistent regression parameters. May lead to serial correlation or heteroskedasticity in the residuals.
Inappropriate transformation	Linear model trying to fit nonlinear relationships.	May lead to heteroskedasticity in the residuals.
Inappropriate variable scaling	Variables are not transformed appropriately.	May lead to multicollinearity or heteroskedasticity in the residuals.
Data improperly pooled	Sample has periods of dissimilar economic environments (i.e., the slope coefficients are unstable).	May lead to heteroskedasticity or serial correlation in the residuals.

LOS 1.h

Violation	Conditional Heteroskedasticity
<i>What is it?</i>	Residual variance is related to level of independent variables
<i>Effect?</i>	Coefficients are consistent. Standard errors are underestimated. Too many Type I errors
<i>Detection?</i>	Breusch-Pagan chi-square test
<i>Correction?</i>	Use robust or White-corrected standard errors

LOS 1.i

Violation	Serial Correlation
<i>What is it?</i>	Residuals are correlated with each other
<i>Effect?</i>	Coefficients are consistent. Standard errors are underestimated. Too many Type I errors (positive correlation).
<i>Detection?</i>	Breusch-Godfrey (BG) <i>F</i> -test
<i>Correction?</i>	Use robust or Newey-West corrected standard errors

LOS 1.j

Violation	Multicollinearity
<i>What is it?</i>	Two or more independent variables are highly correlated
<i>Effect?</i>	Coefficients are consistent (but unreliable). Standard errors are overestimated. Too many Type II errors
<i>Detection?</i>	Conflicting <i>t</i> and <i>F</i> -statistics; high variance inflation factors (VIF)
<i>Correction?</i>	Drop one of the correlated variables, or use a different proxy for an included independent variable

LOS 1.k

Outliers are extreme observations of the dependent or 'Y' variable, while high-leverage points are the extreme observations of the independent or 'X' variables. Influential data points are extreme observations that when excluded cause a significant change in model coefficients, causing the model to perform poorly out-of-sample.

Influential data points should be checked for input errors; alternatively, the observation may be valid but the model incomplete.

LOS 1.l

Qualitative independent variables (dummy variables) capture the effect of a binary independent variable. A dummy variable can be an intercept dummy, or a slope dummy.

LOS 1.m

Qualitative dependent variables (e.g., bankrupt versus non-bankrupt) require methods other than ordinary least squares. Logistic regression (logit) models use log odds as the dependent variable, and the coefficients are estimated using the maximum likelihood estimation methodology. The slope coefficients in a logit model are interpreted as the change in the “log odds” of the event occurring per 1-unit change in the independent variable, holding all other independent variables constant.

ANSWER KEY FOR MODULE QUIZZES

Module Quiz 1.1

- B** Uncovering a pattern in a time series of a single variable can be accomplished using autoregressive models (not multiple regression). Tightening (or not) of monetary policy can be represented as a binary variable and can be modeled using a logistic regression model. Multiple regression models can be used to test existing theories, or identify relationships between variables. (Module 1.1, LOS 1.a)
- B** The interpretation of the intercept 2.30 is the value of the Y variable when both X variables are equal to zero. Individual slope coefficients indicate the % change in Y for a 1% change in X. For a 1% change in X_1 , the change in Y is forecast to be 5.02% and for a 1% increase in X_2 , the forecast change in Y is -4.55%. (Module 1.1, LOS 1.b)
- A** Multiple regression models assume that the relationship between Y and X is linear. The relationship between X variables should not be linear (otherwise, there will be multicollinearity). (Module 1.1, LOS 1.c)

Module Quiz 1.2

- C** $RSS_U = 9,105 - 4,320 = 4,785$; $k = 4$; $n = 65$.

$$F = \frac{(RSS_U)/k}{(SSE_U)/(n - k - 1)} = \frac{4,785/4}{4,320/65 - 4 - 1} = \frac{1,196.25}{72} = 16.61$$

(Module 1.2, LOS 1.e)

- A** $SSE_U = 4,320$; $SSE_R = 5,105$; $n = 65$; $k = 4$, $q = 2$.

$$\frac{(SSE_R - SSE_U)/q}{(SSE_U)/(n - k - 1)} = \frac{(5,105 - 4,320)/2}{4,320/60} = 5.45$$

(Note: while not asked, for 5% significance and dof: $q = 2$, $n - k - 1 = 60$, the critical F -value = 3.15. Since $F > F_{critical}$, we reject the null hypothesis that the coefficients for the last two variables are equal to zero.)

(Module 1.2, LOS 1.e)

3. **A** $SSE = 4,320$, $SST = 9,105$. $RSS = 9,105 - 4,320 = 4,785$. $n = 65$, $k = 4$.

$$R^2 = 4,785 / 9,105 = 0.53.$$

$$R_a^2 = 1 - \left[\left(\frac{n-1}{n-k-1} \right) \times (1 - R^2) \right] = 1 - [(64 / 60) \times (1 - 0.53)] = 0.50$$

(Module 1.2, LOS 1.d)

4. **A** Lower values of the Bayesian information criteria (BIC) indicate better goodness of fit.

$$SSE_U = 4,320, SSE_R = 5,105, n = 65, k_U = 4, k_R = 2.$$

$$SSE_U = 4,320, SSE_R = 5,105, n = 65, k_U = 4, k_R = 2.$$

$$BIC_U = n \times \ln(SSE_U/n) + \ln(n) \times (k_U + 1) \\ = 65 \times \ln(4,320/65) + \ln(65) \times 5 = 273 + 21 = 294$$

$$BIC_R = n \times \ln(SSE_R/n) + \ln(n) \times (k_R + 1) \\ = 65 \times \ln(5,105/65) + \ln(65) \times 3 = 284 + 12 = 296$$

The unrestricted or full model has a lower BIC, and thus a better goodness of fit.

(Module 1.2, LOS 1.d)

Module Quiz 1.3

1. **C** The coefficients column contains the regression parameters. The regression equation is thus $RET = 0.522 + 0.0460(MKT) + 0.7102(IND) + 0.9(FORT)$. (Module 1.1, LOS 1.b)
2. **C** The coefficient on FORT is the amount of the return attributable to the stock of a Fortune 500 firm. All else equal, the return on a Fortune 500 company is expected to exceed the return on a non-Fortune 500 company by 0.9% annually. (Module 1.1, LOS 1.b)
3. **A** The regression equation is $0.522 + 0.0460(MKT) + 0.7102(IND) + 0.9(FORT)$, so $RET = 0.522 + 0.0460(5) + 0.7102(3) + 0.900(0) = 2.88\%$. (Module 1.1, LOS 1.b)
4. **C** The p -value = 0.139 = 13.9%. Because the 13.9% is greater than the 10% significance threshold, we are unable to reject the null hypothesis that the coefficient of FORT = 0. (Module 1.1, LOS 1.b)
5. **C** The Breusch-Pagan test is statistically significant at a 5% level of significance, which indicates heteroskedasticity. (Module 1.3, LOS 1.h)
6. **B** Using leading P/E from a prior period as an independent variable in the regression is unlikely to result in misspecification. Omitting a relevant independent variable from the regression, or using *actual* instead of *expected* inflation (measuring the independent variable in error), are likely to result in model misspecification. (Module 1.3, LOS 1.g)

Module Quiz 1.4

1. **C** The t -statistic for the coefficient of the IND dummy variable is significant and positive. Because the dummy variable is defined as being equal to one for biotechnology stocks, our results indicate that biotechnology P/Es are statistically significantly larger than electric utility P/Es (holding other variables constant). (Module 1.4, LOS 1.l)

2. **B** Note that $IND = 1$ because the stock is in the biotech industry. Predicted $P/E = 6.75 + (8.00 \times 1) + (4.00 \times 0.00) + (12.35 \times 0.14) - (0.50 \times 1.5) = 15.7$. (Module 1.4, LOS 1.l)
3. **C** Depending on the type of misspecification, the regression coefficients may be *biased* and inconsistent, or the residuals may have serial correlation or heteroskedasticity (leading to unreliable standard errors). Notice that choice C states *unbiased* coefficients and not *biased* coefficients. (Module 1.3, LOS 1.g)
4. **C** Both statements are incorrect. To evaluate nested models, a likelihood ratio (LR) test is used for logistic regressions. The LR test statistic has a chi-square distribution, not an F distribution. The slope coefficients in a logit model are interpreted as the change in the *log odds* of the event occurring per 1-unit change in the independent variable, holding all other independent variables constant. (Module 1.4, LOS 1.m)
5. **A**
$$\text{Likelihood ratio (LR)} = -2(\text{Log-likelihood restricted model} - \text{Log-likelihood unrestricted model})$$

$$= -2(-216.22 - (-212.44)) = 7.56$$

Critical chi-square ($q = 2$) = 5.99

LR is greater than the critical value; so we reject the null that the coefficients of excluded variables are all equal to 0. (Module 1.4, LOS 1.m)

¹ Arnott, Robert D., and Clifford S. Asness. "Surprise! Higher Dividends = Higher Earnings Growth." *Financial Analysts Journal* 59, no. 1 (January/February 2003): 70–87.

² Wang, Fenghua, and Yexiao Xu. "What Determines Chinese Stock Returns." *Financial Analysts Journal*, no. 6 (November/December 2004): 65–77.

READING 2

TIME-SERIES ANALYSIS

EXAM FOCUS

A time series is a set of observations of a random variable spaced evenly through time (e.g., quarterly sales revenue for a company over the past 60 quarters). For the exam, given a regression output, identifying violations such as heteroskedasticity, nonstationarity, serial correlation, etc., will be important, as well as being able to calculate a predicted value given a time-series model. Know why a log-linear model is sometimes used; understand the implications of seasonality and how to detect and correct it, as well as the root mean squared error (RMSE) criterion.

MODULE 2.1: LINEAR AND LOG-LINEAR TREND MODELS

LOS 2.a: Calculate and evaluate the predicted trend value for a time series, modeled as either a linear trend or a log-linear trend, given the estimated trend coefficients.

A **time series** is a set of observations for a variable over successive periods of time (e.g., monthly stock market returns for the past 10 years). The series has a **trend** if a consistent pattern can be seen by plotting the data (i.e., the individual observations) on a graph. For example, a seasonal trend in sales data is easily detected by plotting the data and noting the significant jump in sales during the same month(s) each year.

Linear Trend Model

A **linear trend** is a time series pattern that can be graphed using a straight line. A downward sloping line indicates a negative trend, while an upward-sloping line indicates a positive trend.

The simplest form of a linear trend is represented by the following linear trend model:

$$y_t = b_0 + b_1(t) + \epsilon_t$$

where:

y_t = the value of the time series (the dependent variable) at time t

b_0 = intercept at the vertical axis (y-axis)

b_1 = slope coefficient (or trend coefficient)

ϵ_t = error term (or residual term or disturbance term)

t = time (the independent variable); $t = 1, 2, 3 \dots T$

Ordinary least squares (OLS) regression is used to estimate the coefficient in the trend line, which provides the following prediction equation:

$$\hat{y}_t = \hat{b}_0 + \hat{b}_1(t)$$

where:

\hat{y}_t = predicted value of y (the dependent variable) at time t

\hat{b}_0 = estimated value of the intercept term

\hat{b}_1 = estimated value of the slope coefficient

Don't let this model confuse you. It's very similar to the simple linear regression model we covered previously; only here, (t) takes on the value of the time period. For example, in period 2, the equation

becomes:

$$\hat{y}_2 = \hat{b}_0 + \hat{b}_1(2)$$

And, likewise, in period 3:

$$\hat{y}_3 = \hat{b}_0 + \hat{b}_1(3)$$

This means \hat{y} increases by the value of \hat{b}_1 each period.

EXAMPLE: Using a linear trend model

Suppose you are given a linear trend model with $\hat{b}_0 = 1.70$ and $\hat{b}_1 = 3.0$.

Calculate \hat{y}_t for $t = 1$ and $t = 2$.

Answer:

When $t = 1$, $\hat{y}_1 = 1.70 + 3.0(1) = 4.70$

When $t = 2$, $\hat{y}_2 = 1.70 + 3.0(2) = 7.70$

Note that the difference between \hat{y}_1 and \hat{y}_2 is 3.0, or the value of the trend coefficient b_1 .

EXAMPLE: Trend analysis

Consider hypothetical time series data for manufacturing capacity utilization.

Manufacturing Capacity Utilization

Quarter	Time (t)	Manufacturing Capacity Utilization (in %)	Quarter	Time (t)	Manufacturing Capacity Utilization (in %)
2020.1	1	82.4	2021.4	8	80.9
2020.2	2	81.5	2022.1	9	81.3
2020.3	3	80.8	2022.2	10	81.9
2020.4	4	80.5	2022.3	11	81.7
2021.1	5	80.2	2022.4	12	80.3
2021.2	6	80.2	2023.1	13	77.9
2021.3	7	80.5	2023.2	14	76.4

Applying the OLS methodology to fit the linear trend model to the data produces the results shown here.

Time Series Regression Results for Manufacturing Capacity Utilization

Regression model: $y_t = b_0 + b_1t + \epsilon_t$			
R square	0.346		
Adjusted R square	0.292		
Standard error	1.334		
Observations	14		
	Coefficients	Standard Error	t-Statistic
Intercept	82.137	0.753	109.066
Manufacturing utilization	-0.223	0.088	-2.534

Based on this information, predict the projected capacity utilization for the time period involved in the study (i.e., in-sample estimates).

Answer:

As shown in the regression output, the estimated intercept and slope parameters for our manufacturing capacity utilization model are $\hat{b}_0 = 82.137$ and $\hat{b}_1 = -0.223$, respectively. This means that the prediction equation for capacity utilization can be expressed as:

$$\hat{y}_t = 82.137 - 0.223t$$

With this equation, we can generate estimated values for capacity utilization, \hat{y}_t , for each of the 14 quarters in the time series. For example, using the model capacity utilization for the first quarter of 2020 is estimated at 81.914:

$$\hat{y}_t = 82.137 - 0.223(1) = 82.137 - 0.223 = 81.914$$

Note that the estimated value of capacity utilization in that quarter (using the model) is not exactly the same as the actual, measured capacity utilization for that quarter (82.4). The difference between the two is the error or residual term associated with that observation:

$$\begin{aligned} \text{Residual (error)} &= \text{actual value} - \text{predicted value} \\ &\approx 82.4 - 81.914 = 0.486 \end{aligned}$$

Note that since the actual, measured value is greater than the predicted value of y for 2020.1, the error term is positive. Had the actual, measured value been less than the predicted value, the error term would have been negative.

The projections (i.e., values generated by the model) for all quarters are compared to the actual values here.

Projected Versus Actual Capacity Utilization

Quarter	Time	\hat{y}_t	y_t	Quarter	Time	\hat{y}_t	y_t
2020.1	1	81.914	82.4	2021.4	8	80.353	80.9
2020.2	2	81.691	81.5	2022.1	9	80.130	81.3
2020.3	3	81.468	80.8	2022.2	10	79.907	81.9
2020.4	4	81.245	80.5	2022.3	11	79.684	81.7
2021.1	5	81.022	80.2	2022.4	12	79.460	80.3
2021.2	6	80.799	80.2	2023.1	13	79.237	77.9
2021.3	7	80.576	80.5	2023.2	14	79.014	76.4

The following graph shows visually how the predicted values compare to the actual values, which were used to generate the regression equation. The **residuals**, or **error terms**, are represented by the distance between the predicted (straight) regression line and the actual data plotted in blue. For example, the residual for $t=10$ is $81.9 - 79.907=1.993$.

Predicted vs. Actual Capacity Utilization

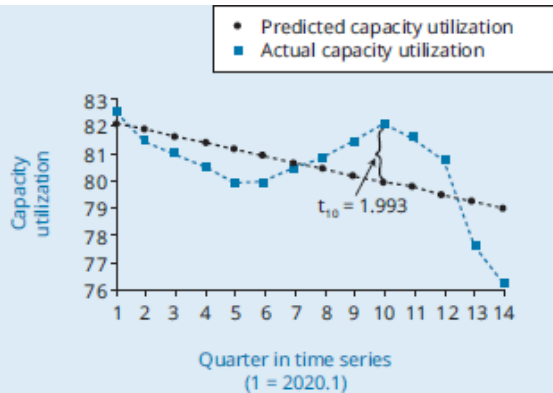

Since we utilized a linear regression model, the predicted values will by definition fall on a straight line. Since the raw data does not display a linear relationship, the model will probably not do a good job of predicting future values.

Log-Linear Trend Models

Time series data, particularly financial time series, often display *exponential growth* (growth with continuous compounding). Positive exponential growth means that the random variable (i.e., the time series) tends to increase at some constant rate of growth. If we plot the data, the observations will form a convex curve. Negative exponential growth means that the data tends to decrease at some constant rate of decay, and the plotted time series will be a concave curve.

When a series exhibits exponential growth, it can be modeled as:

$$y_t = e^{b_0 + b_1(t)}$$

where:

y_t = value of the dependent variable at time t

b_0 = intercept term

b_1 = constant rate of growth

e = base of the natural logarithm

t = time = 1, 2, 3...T

This model defines y , the dependent variable, as an *exponential* function of time, the independent variable. Rather than try to fit the nonlinear data with a linear (straight line) regression, we take the natural log of both sides of the equation and arrive at the *log-linear* model. This is frequently used when time series data exhibit exponential growth.

$$\ln(y_t) = \ln(e^{b_0 + b_1(t)}) \Rightarrow \ln(y_t) = b_0 + b_1(t)$$

Now that the equation has been transformed from an exponential to a linear function, we can use a linear regression technique to model the series. The use of the transformed data produces a *linear* trend line with a better fit for the data and increases the predictive ability of the model.

EXAMPLE: Log-linear trend model

An analyst estimates a log-linear trend model using quarterly revenue data (in millions of \$) from the first quarter of 2012 to the fourth quarter of 2023 for JP Northfield, Inc.:

$$\ln \text{ revenue}_t = b_0 + b_1(t) + \varepsilon_t$$

$$t = 1, 2, \dots, 48$$

The results are shown in the following table.

	Coefficient	Standard Error	t-statistic
Intercept	4.00	0.05	80.0
Trend	0.09	0.01	9.0

Calculate JP Northfield's predicted revenues in the first quarter of 2024.

Answer:

In the first quarter of 2024, t is equal to 49 because the sample has 48 observations.

$$\ln \text{revenue}_{49} = 4.00 + 0.09(49) = 8.41$$

$$\text{revenue}_{49} = e^{\ln \text{revenue}_{49}} = e^{8.41} = \$4,492 \text{ million}$$

The first answer you get in this calculation is the natural log of the revenue forecast. In order to turn the natural log into a revenue figure, you use the 2nd function of the LN key (e^x) on your BA II Plus: enter 8.41 and press [2nd] e^x = 4,492 million.

LOS 2.b: Describe factors that determine whether a linear or a log-linear trend should be used with a particular time series and evaluate limitations of trend models.

Factors that Determine Which Model is Best

To determine if a linear or log-linear trend model should be used, the analyst should plot the data. A *linear trend model* may be appropriate if the data points appear to be equally distributed above and below the regression line. Inflation rate data can often be modeled with a linear trend model.

If, on the other hand, the data plots with a non-linear (curved) shape, then the residuals from a linear trend model will be persistently positive or negative for a period of time. In this case, the *log-linear model* may be more suitable. In other words, when the residuals from a linear trend model are serially correlated, a log-linear trend model may be more appropriate. By taking the log of the y variable, a regression line can better fit the data. Financial data (e.g., stock indices and stock prices) and company sales data are often best modeled with log-linear models.

Figure 2.1 shows a time series that is best modeled with a log-linear trend model rather than a linear trend model.

Figure 2.1: Linear vs. Log-Linear Trend Models

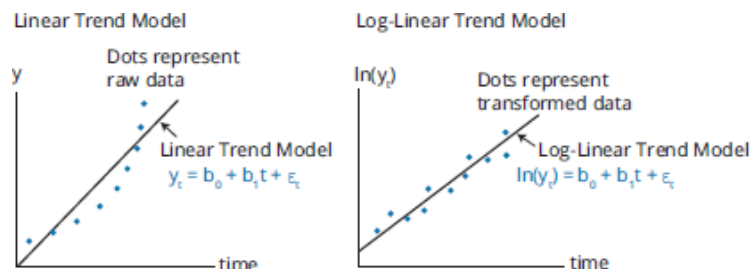

The left panel is a plot of data that exhibits exponential growth along with a linear trend line. The panel on the right is a plot of the natural logs of the original data and a representative log-linear trend line. The log-linear model fits the transformed data better than the linear trend model and, therefore, yields more accurate forecasts.

The bottom line is that when a variable grows at a constant *rate*, a log-linear model is most appropriate. When the variable increases over time by a constant *amount*, a linear trend model is most appropriate.

Limitations of Trend Models

Recall that one of the assumptions underlying linear regression is that the residuals are uncorrelated with each other. A violation of this assumption is referred to as autocorrelation. For AR models (where the lagged dependent variable is an independent variable), presence of serial correlation in residuals indicates that the model is misspecified. This is a significant limitation, as it means that the model is not appropriate for the time series and that we should not use it to predict future values.

In the preceding discussion, we suggested that a log-linear trend model would be better than a linear trend model when the variable exhibits a constant growth rate. However, it may be the case that even a log-linear model is not appropriate in the presence of serial correlation. In this case, we will want to turn to an autoregressive model.

Recall from the previous topic review that the Durbin-Watson statistic (DW) is used to detect autocorrelation. For a time series model without serial correlation DW should be approximately equal to 2.0. A DW significantly different from 2.0 suggests that the residual terms are correlated.



MODULE QUIZ 2.1

Use the following information to answer Questions 1 through 4.

Consider the results of the regression of monthly real estate loans (RE) in billions of dollars by commercial banks over the period January 2020 through September 2023 in the following table:

Time Series Regression Results for Real Estate Loans

Model: $RE_t = b_0 + b_1t + \varepsilon_t$ $t = 1, 2, \dots, 45$	
R ²	0.967908
Adjusted R ²	0.9671617
Standard error	29.587649
Observations	45
Durbin-Watson	0.601

	Coefficients	Standard Error
Intercept	1195.6241	8.9704362
b_1	12.230448	0.3396171

- The regression of real estate loans against time is a(n):
 - trend model.
 - AR model.
 - ARCH model.
- The results of the estimation indicate an:
 - upward trend.
 - AR(2) model.
 - ARCH system.
- Are the intercept and slope coefficient significantly different from zero at the 5% level of significance?
 - Both are statistically significant.
 - One is, but the other is not.
 - Neither of them is statistically significant.
- The forecasted value of real estate loans for October 2023 is *closest* to:
 - \$1,733.764 billion.
 - \$1,745.990 billion.
 - \$1,758.225 billion.
- An analyst has determined that monthly sport utility vehicle (SUV) sales in the United States have been increasing over the last 10 years, but the growth rate over that period has been relatively constant. Which model is *most appropriate* to predict future SUV sales?
 - $SUVsales_t = b_0 + b_1(t) + e_t$
 - $\ln SUVsales_t = b_0 + b_1(t) + e_t$

$$C. \ln \text{SUVsales}_t = b_0 + b_1(\text{SUVsales}_{t-1}) + e_t.$$

MODULE 2.2: AUTOREGRESSIVE (AR) MODELS



Video covering this content is available online.

LOS 2.c: Explain the requirement for a time series to be covariance stationary and describe the significance of a series that is not stationary.

When the dependent variable is regressed against one or more lagged values of itself, the resultant model is called as an **autoregressive model** (AR). For example, the sales for a firm could be regressed against the sales for the firm in the previous month.

Consider:

$$x_t = b_0 + b_1 x_{t-1} + e_t$$

where:

x_t = value of time series at time t

b_0 = intercept at the vertical axis (y-axis)

b_1 = slope coefficient

x_{t-1} = value of time series at time $t - 1$

e_t = error term (or residual term or disturbance term)

t = time; $t = 1, 2, 3 \dots T$

In an autoregressive time series, past values of a variable are used to predict the current (and hence future) value of the variable.

Statistical inferences based on ordinary least squares (OLS) estimates for an AR time series model may be invalid unless the time series being modeled is **covariance stationary**.

A time series is covariance stationary if it satisfies the following three conditions:

1. *Constant and finite expected value.* The expected value of the time series is constant over time. (Later, we will refer to this value as the mean-reverting level.)
2. *Constant and finite variance.* The time series' volatility around its mean (i.e., the distribution of the individual observations around the mean) does not change over time.
3. *Constant and finite covariance between values at any given lag.* The covariance of the time series with leading or lagged values of itself is constant.

LOS 2.d: Describe the structure of an autoregressive (AR) model of order p and calculate one- and two-period-ahead forecasts given the estimated coefficients.

The following model illustrates how variable x would be regressed on itself with a lag of one and two periods:

$$x_t = b_0 + b_1 x_{t-1} + b_2 x_{t-2} + e_t$$

Such a model is referred to as a *second-order* autoregressive model, or an AR(2) model. In general, an AR model of order p , AR(p), is expressed as:

$$x_t = b_0 + b_1 x_{t-1} + b_2 x_{t-2} + \dots + b_p x_{t-p} + e_t$$

where p indicates the number of lagged values that the AR model will include as independent variables.

Forecasting With an Autoregressive Model

Autoregressive time series model forecasts are calculated in the same manner as those for other regression models, but since the independent variable is a lagged value of the dependent variable, it is

necessary to calculate a one-step-ahead forecast before a two-step-ahead forecast can be calculated. The calculation of successive forecasts in this manner is referred to as the **chain rule of forecasting**.

A one-period-ahead forecast for an AR(1) model is determined in the following manner:

$$\hat{x}_{t+1} = \hat{b}_0 + \hat{b}_1 x_t$$

Likewise, a two-step-ahead forecast for an AR(1) model is calculated as:

$$\hat{x}_{t+2} = \hat{b}_0 + \hat{b}_1 \hat{x}_{t+1}$$

Note that the ^ symbol above the variables in the equations indicates that the inputs used in multi-period forecasts are actually forecasts (estimates) themselves. This implies that multi-period forecasts are more uncertain than single-period forecasts. For example, for a two-step-ahead forecast, there is the usual uncertainty associated with forecasting x_{t+1} using x_t , plus the additional uncertainty of forecasting x_{t+2} using the forecasted value for x_{t+1} .

EXAMPLE: Forecasting

Suppose that an AR(1) model has been estimated and has produced the following prediction equation: $x_t = 1.2 + 0.45x_{t-1}$. Calculate a two-step-ahead forecast if the current value of x is 5.0.

Answer:

One-step-ahead forecast: If $x_t = 5$, then $\hat{x}_{t+1} = 1.2 + 0.45(5) = 3.45$.

Two-step-ahead forecast: If $\hat{x}_{t+1} = 3.45$, then $\hat{x}_{t+2} = 1.2 + 0.45(3.45) = 2.75$.

LOS 2.e: Explain how autocorrelations of the residuals can be used to test whether the autoregressive model fits the time series.

Autocorrelation & Model Fit

When an AR model is correctly specified, the residual terms will not exhibit *serial correlation*. Serial correlation (or autocorrelation) means the error terms are positively or negatively correlated. When the error terms are correlated, standard errors are unreliable and t -tests of individual coefficients can incorrectly show statistical significance or insignificance.

If the residuals have significant autocorrelation, the AR model that produced the residuals is not the best model for the time series being analyzed. The procedure to test whether an AR time series model is correctly specified involves three steps:

Step 1: Estimate the AR model being evaluated using linear regression:

Start with a first-order AR model [i.e., AR(1)] using $x_t = b_0 + b_1 x_{t-1} + \varepsilon_t$.

Step 2: Calculate the autocorrelations of the model's residuals (i.e., the level of correlation between the forecast errors from one period to the next).

Step 3: Test whether the autocorrelations are significantly different from zero:

If the model is correctly specified, none of the autocorrelations will be statistically significant. To test for significance, a t -test is used to test the hypothesis that the correlations of the residuals are zero. The t -statistic is the estimated autocorrelation divided by the standard error. The standard error is $1/\sqrt{T}$, where T is the number of observations, so the test statistic for each autocorrelation is $t = \frac{\rho_{\varepsilon_t, \varepsilon_{t-k}}}{1/\sqrt{T}}$ with $(T - 2)$ degrees of freedom and $\rho_{\varepsilon_t, \varepsilon_{t-k}}$ is the correlation of error

term t with the k th lagged error term.



PROFESSOR'S NOTE

The Durbin-Watson test that we used with trend models is not appropriate for testing for serial correlation of the error terms in an autoregressive model. Use this t -test instead.

EXAMPLE: Testing an AR model for proper specification

The correlations of the error terms from the estimation of an AR(1) model using a sample with 102 observations are presented in the following figure. Determine whether the model is correctly specified.

Autocorrelation Analysis

$$\text{Model: } y_t = b_0 + b_1 y_{t-1} + \varepsilon_t$$

Lag	Autocorrelation	t -Statistic	Lag	Autocorrelation	t -Statistic
1	0.0616114	0.622245	7	-0.010146	-0.102470
2	0.0843368	0.851760	8	0.0211711	0.213818
3	0.0258823	0.261398	9	-0.0959502	-0.969050
4	0.0188928	0.190808	10	0.0389730	0.393608
5	0.1001404	1.011368	11	-0.0677132	-0.683870
6	-0.0638219	-0.644570	12	-0.0122798	-0.124020

Answer:

In this example, the standard error is $1/\sqrt{102}$ or 0.099. The t -statistic for Lag 2 is then computed as $0.0843368 / 0.099 = 0.8518$.

The critical two-tail t -value at the 5% significance level and 100 degrees of freedom is 1.98. The t -statistics indicate that none of the autocorrelations of the residuals in the previous figure is statistically different from zero because their absolute values are less than 1.98. Thus, there is sufficient reason to believe that the error terms from the AR(1) model are not serially correlated.

If the t -tests indicate that any of the correlations computed in Step 2 are statistically significant (i.e., $t \geq 1.98$), the AR model is not specified correctly. Additional lags are included in the model and the correlations of the residuals (error terms) are checked again. This procedure will be followed until all autocorrelations are insignificant.

LOS 2.f: Explain mean reversion and calculate a mean-reverting level.

A time series exhibits **mean reversion** if it has a tendency to move toward its mean. In other words, the time series has a tendency to decline when the current value is above the mean and rise when the current value is below the mean. If a time series is at its **mean-reverting level**, the model predicts that the next value of the time series will be the same as its current value (i.e., $\hat{x}_t = x_{t-1}$ when a time series is at its mean-reverting level).

For an AR(1) model, $x_t = b_0 + b_1 x_{t-1}$, the equality implies that $x_t = b_0 + b_1 x_t$.

Solving for x_t , the mean-reverting level is expressed as $x_t = \frac{b_0}{(1 - b_1)}$.

So, if $x_t > \frac{b_0}{(1 - b_1)}$, the AR(1) model predicts that x_{t+1} will be lower than x_t and

if $x_t < \frac{b_0}{1 - b_1}$, the model predicts that x_{t+1} will be higher than x_t .

EXAMPLE: Mean-reverting time series

Calculate the mean-reverting level for the manufacturing capacity utilization time series using the following regression results:

Time Series Regression Results for Manufacturing Capacity Utilization

Regression model: $x_t = b_0 + b_1x_{t-1}$			
R square	0.346508		
Adjusted R square	0.29205		
Standard error	1.333885		
Observations	14		
	<i>Coefficients</i>	<i>Standard Error</i>	<i>t-Statistic</i>
Intercept	82.137	0.753	109.080
Manufacturing utilization	-0.223	0.0884	-2.522

Answer:

$b_0 = 82.137$ and $b_1 = -0.223$, so the mean-reverting level, $b_0 / (1 - b_1)$, is computed as: mean-reverting level = $\frac{82.137}{[1 - (-0.223)]} = 67.16$

This means that if the current level of manufacturing capacity utilization is above 67.16, it is expected to fall in the next period, and if manufacturing capacity utilization is below 67.16 in the current period, it is expected to rise in the next period.

All covariance stationary time series have a finite mean-reverting level. An AR(1) time series will have a finite mean-reverting level when the absolute value of the lag coefficient is less than 1 (i.e., $|b_1| < 1$).

LOS 2.g: Contrast in-sample and out-of-sample forecasts and compare the forecasting accuracy of different time-series models based on the root mean squared error criterion.

In-sample forecasts (\hat{y}_t) are *within* the range of data (i.e., time period) used to estimate the model, which for a time series is known as the sample or test period. In-sample forecast errors are $(y_t - \hat{y}_t)$, where t is an observation within the sample period. In other words, we are comparing how accurate our model is in forecasting the actual data we used to develop the model. The Predicted vs. Actual Capacity Utilization figure in our Trend Analysis example shows an example of values predicted by the model compared to the values used to generate the model.

Out-of-sample forecasts are made *outside* of the sample period. In other words, we compare how accurate a model is in forecasting the y variable value for a time period outside the period used to develop the model. Out-of-sample forecasts are important because they provide a test of whether the model adequately describes the time series and whether it has relevance (i.e., predictive power) in the real world. Nonetheless, an analyst should be aware that most published research employs in-sample forecasts only.

The **root mean squared error (RMSE)** criterion is used to compare the accuracy of autoregressive models in forecasting out-of-sample values. For example, a researcher may have two autoregressive (AR) models: an AR(1) model and an AR(2) model. To determine which model will more accurately forecast future values, we calculate the RMSE (the square root of the average of the squared errors) for the out-of-sample data. Note that the model with the lowest RMSE for in-sample data may not be the model with the lowest RMSE for out-of-sample data.

For example, imagine that we have 60 months of historical unemployment data. We estimate both models over the first 36 of 60 months. To determine which model will produce better (i.e., more accurate) forecasts, we then forecast the values for the last 24 of 60 months of historical data. Using the actual values for the last 24 months as well as the values predicted by the models, we can calculate the RMSE for each model.

The model with the lower RMSE for the out-of-sample data will have lower forecast error and will be expected to have better predictive power in the future.

In addition to examining the RMSE criteria for a model, we will also want to examine the stability of regression coefficients, which we discuss in the following.

LOS 2.h: Explain the instability of coefficients of time-series models.

Financial and economic time series inherently exhibit some form of *instability* or *nonstationarity*. This is because financial and economic conditions are dynamic, and the estimated regression coefficients in one period may be quite different from those estimated during another period.

Models estimated with shorter time series are usually more stable than those with longer time series because a longer sample period increases the chance that the underlying economic process has changed. Thus, there is a tradeoff between the increased statistical reliability when using longer time periods and the increased stability of the estimates when using shorter periods.

The primary concern when selecting a time series sample period is the underlying economic processes. Have there been regulatory changes? Has there been a dramatic change in the underlying economic environment?

If the answer is yes, then the historical data may not provide a reliable model. Merely examining the significance of the autocorrelation of the residuals will not indicate whether the model is valid. We must also examine whether the data is covariance stationary.



MODULE QUIZ 2.2

1. Is the time series shown in the following figure likely to be covariance stationary?

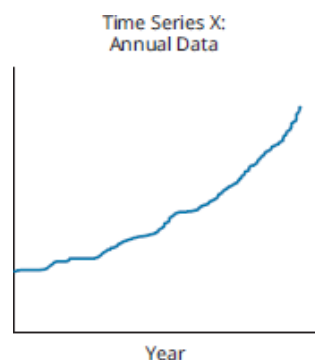

- A. X is not covariance stationary due to homoskedasticity.
B. X is not covariance stationary due to non-constant mean.
C. X is covariance stationary.
2. Given the prediction equation: $\hat{x}_t = 5 + 1.75x_{t-1}$, what is the forecast value of x_{t+2} if x_{t-1} is 16.5?
A. 64.28.
B. 117.49.
C. 210.61.
3. When evaluating a time series model's real-world ability to forecast, we would have the most confidence in a model with small:
A. in-sample forecast error.
B. out-of-sample forecast error.

MODULE 2.3: RANDOM WALKS AND UNIT ROOTS



Video covering this content is available online.

LOS 2.i: Describe characteristics of random walk processes and contrast them to covariance stationary processes.

Random walk. If a time series follows a random walk process, the predicted value of the series (i.e., the value of the dependent variable) in one period is equal to the value of the series in the previous period plus a random error term.

A time series that follows a simple random walk process is described in equation form as $x_t = x_{t-1} + \varepsilon_t$, where the best forecast of x_t is x_{t-1} and:

1. $E(\varepsilon_t) = 0$: The expected value of each error term is zero.
2. $E(\varepsilon_t^2) = \sigma^2$: The variance of the error terms is constant.
3. $E(\varepsilon_i \varepsilon_j) = 0$; if $i \neq j$: There is no serial correlation in the error terms.

Random walk with a drift. If a time series follows a random walk *with a drift*, the intercept term is not equal to zero. That is, in addition to a random error term, the time series is expected to increase or decrease by a constant amount each period. A random walk with a drift can be described as:

$$x_t = b_0 + b_1 x_{t-1} + \varepsilon_t$$

where:
 $b_0 =$ the constant drift
 $b_1 = 1$

Covariance stationarity. Neither a random walk nor a random walk with a drift exhibits covariance stationarity. To show this, let's start by expressing a random walk as:

$$x_t = b_0 + b_1 x_{t-1} + \varepsilon_t$$

where:
 $b_0 = 0$ (for a random walk without a drift)
 $b_0 \neq 0$ (for a random walk with a drift)
 $b_1 = 1$ (for a random walk with or without a drift)

In either case (with or without a drift), the mean-reverting level is $\frac{b_0}{1-b_1} = \frac{b_0}{0}$ (the division of any number by zero is undefined), and as we stated earlier, a time series must have a **finite mean-reverting level** to be covariance stationary. Thus, a random walk, with or without a drift, is not covariance stationary, and exhibits what is known as a **unit root** ($b_1 = 1$). For a time series that is not covariance stationary, the least squares regression procedure that we have been using to estimate an AR(1) model will not work without transforming the data. We discuss unit roots and how they are handled in the next section.

LOS 2.j: Describe implications of unit roots for time-series analysis, explain when unit roots are likely to occur and how to test for them, and demonstrate how a time series with a unit root can be transformed so it can be analyzed with an AR model.

LOS 2.k: Describe the steps of the unit root test for nonstationarity and explain the relation of the test to autoregressive time-series models.

As we discussed in the previous LOS, if the coefficient on the lag variable is 1, the series is not covariance stationary. If the value of the lag coefficient is equal to one, the time series is said to have a **unit root** and will follow a random walk process. Since a time series that follows a random walk is not covariance stationary, modeling such a time series in an AR model can lead to incorrect inferences.

Unit Root Testing for Nonstationarity

To determine whether a time series is covariance stationary, we can (1) run an AR model and examine autocorrelations, or (2) perform the Dickey-Fuller test.

In the first method, an AR model is estimated and the statistical significance of the autocorrelations at various lags is examined. A stationary process will usually have residual autocorrelations insignificantly different from zero at all lags or residual autocorrelations that decay to zero as the number of lags increases.

A more definitive test for unit root is the **Dickey-Fuller** test. For statistical reasons, you cannot directly test whether the coefficient on the independent variable in an AR time series is equal to 1. To compensate, Dickey and Fuller created a rather ingenious test for a unit root. Remember, if an AR(1) model has a coefficient of 1, it has a unit root and no finite mean reverting level (i.e., it is not covariance stationary). Dickey and Fuller (DF) transform the AR(1) model to run a simple regression. To transform the model, they (1) start with the basic form of the AR(1) model and (2) subtract x_{t-1} from both sides:

$$(1) x_t = b_0 + b_1 x_{t-1} + \epsilon$$

$$(2) x_t - x_{t-1} = b_0 + b_1 x_{t-1} - x_{t-1} + \epsilon \rightarrow$$

$$x_t - x_{t-1} = b_0 + (b_1 - 1) x_{t-1} + \epsilon$$

Then, rather than directly testing whether the original coefficient is different from 1, they test whether the new, transformed coefficient ($b_1 - 1$) is different from zero using a modified t -test. If ($b_1 - 1$) is not significantly different from zero, they say that b_1 must be equal to 1.0 and, therefore, the series must have a unit root.



PROFESSOR'S NOTE

In their actual test, Dickey and Fuller use the variable g , which equals $(b_1 - 1)$. The null hypothesis is $g = 0$ (i.e., the time series has a unit root). For the exam, understand how the test is conducted and be able to interpret its results. For example, if on the exam you are told the null ($g = 0$) cannot be rejected, your answer is that the time series has a unit root. If the null is rejected, the time series does not have a unit root.

First Differencing

If we believe a time series is a random walk (i.e., has a unit root), we can transform the data to a covariance stationary time series using a procedure called **first differencing**. The first differencing process involves subtracting the value of the time series (i.e., the dependent variable) in the immediately preceding period from the current value of the time series to define a new dependent variable, y . Note that by taking first differences, you model the **change** in the value of the dependent variable

So, if the original time series of x has a unit root, the change in x , $x_t - x_{t-1} = \epsilon_t$, is just the error term. This means we can define y_t as:

$$y_t = x_t - x_{t-1} \Rightarrow y_t = \epsilon_t$$

Then, stating y in the form of an AR(1) model:

$$y_t = b_0 + b_1 y_{t-1} + \epsilon_t$$

where:

$$b_0 = b_1 = 0$$

This transformed time series has a finite mean-reverting level of $\frac{0}{1-0} = 0$ and is, therefore, covariance stationary.

EXAMPLE: Unit root

Suppose we decide to model the capacity utilization data. Using an AR(1) model, the results indicate that the capacity utilization time series probably contains a unit root and is, therefore, not covariance stationary. Discuss how this time series can be transformed to be covariance stationary.

Answer:

Covariance stationarity can often be achieved by transforming the data using first differencing and modeling the first-differenced time series as an autoregressive time series.

EXAMPLE: First differencing

The next figure contains the first-differences of our manufacturing capacity utilization time series for the period 2020.1 through 2023.3. The first two columns contain the original time series. The first differences of the original series are contained in the third column of the table, and the one-period lagged values on the first-differences are presented in the fourth column of the table. Note that the first differences in this example represent the *change* in manufacturing capacity from the preceding period and are designated as y_t and y_{t-1} .

First-Differenced Manufacturing Capacity Utilization Data

Quarter	Capacity	Change in Capacity	Lagged Change in Capacity
		$y_t = x_t - x_{t-1}$	$y_{t-1} = x_{t-1} - x_{t-2}$
2020.1	82.4		
2020.2	81.5	-0.9	
2020.3	80.8	-0.7	-0.9
2020.4	80.5	-0.3	-0.7
2021.1	80.2	-0.3	-0.3
2021.2	80.2	0.0	-0.3
2021.3	80.5	0.3	0.0
2021.4	80.9	0.4	0.3
2022.1	81.3	0.4	0.4
2022.2	81.9	0.6	0.4
2022.3	81.7	-0.2	0.6
2022.4	80.3	-1.4	-0.2
2023.1	77.9	-2.4	-1.4
2023.2	76.4	-1.5	-2.4
2023.3	76.4	0.0	-1.5

After this transformation, it is appropriate to regress the AR(1) model, $y_t = b_0 + b_1 y_{t-1}$. The regression results for the first-differenced time series are presented in the next figure, where it can be seen that the estimated coefficient on the lag variable is statistically significant at 5% level of significance.

Regression Output for First-Differenced Manufacturing Capacity

Change in Capacity Utilization

AR(1) Model $y_t = b_0 + b_1 y_{t-1} + \varepsilon_t$

R ²	0.430869388
Adjusted R ²	0.379130241
Standard error	0.699210366
Observations	13

	<i>Coefficients</i>	<i>Standard Error</i>	<i>t-Statistic</i>	<i>p-Value</i>
Intercept	-0.090014589	0.220409703	-0.4084	0.69082
Lag 1	0.65496839	0.226964091	2.885780	0.0148



MODULE QUIZ 2.3

Use the following information to answer Questions 1 and 2.

The results of the estimation of monthly revolving credit outstanding (RCO) on the one-period lagged values for RCO from January 2020 through December 2022 are presented in the following table.

Regression Results for Outstanding Revolving Credit Study

Model: $RCO_t = b_0 + b_1 RCO_{t-1} + \varepsilon_t$				
R ²	0.952643			
Adjusted R ²	0.951208			
Standard error	9.261452			
Observations	35			
	<i>Coefficients</i>	<i>Standard Error</i>	<i>t-Statistic</i>	<i>p-Value</i>
Intercept	-34.0019	24.19417	-1.40537	0.169255
Lag 1	1.065697	0.041362	25.76512	< 0.0001

- What type of time-series model was used to produce the regression results in the table? A(n):
 - AR model.
 - heteroskedasticity (H) model.
 - trend model with a drift.
- An approach that may work in the case of modeling a time series that has a unit root is to:
 - use an ARCH model.
 - use a trend model.
 - model the first differences of the time series.
- Which of the following will always have a finite mean-reverting level?
 - A covariance-stationary time series.
 - A random-walk-with-drift time series.
 - A time series with unit root.
- Which of the following statements is *most accurate*? A random walk process:
 - is nonstationary.
 - has a finite mean-reverting level.
 - can be appropriately fit as an AR(1) model.
- Which of the following is not correct about the Dickey-Fuller unit root test for nonstationarity?
 - The null hypothesis is that the time series has a unit root.
 - A hypothesis test is conducted using critical values computed by Dickey and Fuller in place of conventional *t*-test values.

C. If the test statistic is significant, we conclude that the times series is nonstationary.

MODULE 2.4: SEASONALITY



Video covering this content is available online.

LOS 2.I: Explain how to test and correct for seasonality in a time-series model and calculate and interpret a forecasted value using an AR model with a seasonal lag.

Seasonality in a time-series is a pattern that tends to repeat from year to year. One example is monthly sales data for a retailer. Given that sales data normally vary according to the time of year, we might expect this month's sales (x_t) to be related to sales for the same month last year (x_{t-12}).

When seasonality is present, modeling the associated time series data would be misspecified unless the AR model incorporates the effects of the seasonality.

EXAMPLE: Detecting seasonality

You are interested in predicting occupancy levels for a resort hotel chain and have obtained the chain's quarterly occupancy levels for the most recent 40 quarters (10 years). You decide to model the quarterly occupancy time-series using the AR(1) model:

$$\ln x_t = b_0 + b_1 \ln x_{t-1} + \varepsilon_t$$

Determine whether seasonality exists using the results presented in the following example.

Autoregression Output for Log-Quarterly Hotel Occupancy

Resort Occupancy Levels			
AR(1) Model: $\ln x_t = b_0 + b_1 \ln x_{t-1} + \varepsilon_t$			
R ²	0.7929		
Standard error	0.1952		
Observations	39		
	Coefficients	Standard Error	t-Statistic
Intercept	0.0375	0.0274	1.369
Lag 1	0.5318	0.1635	3.2526
Autocorrelation of Residuals			
Residual Lag	Autocorrelation	Standard Error	t-Statistic
1	-0.0615	0.1601	-0.3841
2	-0.0121	0.1601	-0.0756
3	-0.0212	0.1601	-0.1324
4	0.8719	0.1601	5.4460

Answer:

The bottom part of the table contains the residual autocorrelations for the first four lags of the time series. What stands out is the relatively large autocorrelation and t -statistic for the fourth lag. With 39 observations and two parameters, (b_0 and b_1), there are 37 degrees of freedom. At a significance level of 5%, the critical t -value is 2.026.

The t -statistics indicate that none of the first three lagged autocorrelations is significantly different from zero. However, the t -statistic at Lag 4 is 5.4460, which means that we must reject the null hypothesis that the Lag 4 autocorrelation is zero and conclude that seasonality is present in the time-series. Thus, we conclude that this model is misspecified and will be unreliable for forecasting purposes. We need to include a seasonality term to make the model more correctly specified.

**PROFESSOR'S NOTE**

The reason 40 quarters of data only produces 39 observations is because we're analyzing the difference from one quarter to the next; 40 data points yields 39 differences.

Correcting for seasonality. The interpretation of seasonality in the previous example is that occupancy in any quarter is related to occupancy in the previous quarter and the same quarter in the previous year. For example, fourth quarter 2022 occupancy is related to third quarter 2022 occupancy as well as fourth quarter 2021 occupancy.

To adjust for seasonality in an AR model, an additional **lag** of the *dependent* variable (corresponding to the same period in the previous year) is added to the original model as another *independent* variable. For example, if quarterly data are used, the **seasonal lag** is 4; if monthly data are used the seasonal lag is 12; and so on.

EXAMPLE: Correcting for seasonality in a time-series model

We continue with our resort occupancy level example, where the significant residual correlation at Lag 4 indicates seasonality in the quarterly time series. By testing the correlations of the error terms, it appears that occupancy levels in each quarter are related not only to the previous quarter, but also to the corresponding quarter in the previous year. To adjust for this problem, we add a lagged value of the dependent variable to the original model that corresponds to the seasonal pattern.

To model the autocorrelation of the same quarters from year to year, we use an AR(1) model with a seasonal lag: $\ln x_t = b_0 + b_1(\ln x_{t-1}) + b_2(\ln x_{t-4}) + \varepsilon_t$. Note that this specification, the inclusion of a seasonal lag, does not result in an AR(2) model. It results in an AR(1) model incorporating a seasonal lag term.

The results obtained when this model is fit to the natural logarithm of the time series are presented in the following. Determine whether the model is specified correctly.

Log-Resort Hotel Occupancy			
AR(1) Model with a Seasonal Lag: $\ln x_t = b_0 + b_1(\ln x_{t-1}) + b_2(\ln x_{t-4}) + \varepsilon_t$			
R ²	0.948983874		
Standard error	0.3754		
Observations	36		
	Coefficients	Standard Error	t-Statistic
Intercept	0.0085	0.0049	1.7347
Lag 1	0.2598	0.0527	4.9298
Lag 4	0.7921	0.2166	3.6570
Autocorrelation of Residuals			
Residual Lag	Autocorrelation	Standard Error	t-Statistic
1	-0.0526	0.1667	-0.3156
2	0.0715	0.1667	0.4290
3	-0.0241	0.1667	-0.1446
4	-0.0435	0.1667	-0.2610

Answer:

Notice in the bottom of the table that the fourth-lag residual autocorrelation has dropped substantially and is, in fact, no longer statistically significant. Also notable in these results is the improvement in the R-square for the adjusted model (94.9%) compared to the R-square from the

original model (79.3%). The results shown in the figure indicate that, by incorporating a seasonal lag term, the model is now specified correctly.

Forecasting Using an AR Model with a Seasonal Lag

EXAMPLE: Forecasting with an autoregressive model

Based on the regression results from the previous example and the occupancy levels over the past year (presented next), forecast the level of hotel occupancy for the first quarter of 2023.

Quarterly Hotel Occupancy Levels

Quarter	2022.1	2022.2	2022.3	2022.4
Occupancy Level	250,000	750,000	450,000	600,000

Answer:

We express the seasonally adjusted forecasting equation as:

$$\ln x_t = 0.0085 + 0.2598(\ln x_{t-1}) + 0.7921(\ln x_{t-4})$$

where x_t is the occupancy level for the t th quarter.

To forecast the occupancy level for the hotel chain for the first quarter of 2023 (i.e., 2023.1), the following computation is made:

$$\ln y_{2023.1} = 0.0085 + 0.2598(\ln y_{2022.4}) + 0.7921(\ln y_{2022.1})$$

$$\ln y_{2023.1} = 0.0085 + 0.2598(\ln 600,000) + 0.7921(\ln 250,000)$$

$$\ln y_{2023.1} = 0.0085 + 0.2598(13.3047) + 0.7921(12.4292)$$

$$\ln y_{2023.1} = 13.3103$$

$$\text{Since } y = e^{\ln(y)}, y_{2023.1} = e^{13.3103} = 603,378.52$$

The forecasted level of hotel occupancy for the first quarter of 2023 is 603,379, a significant increase over the same quarter the previous year.



PROFESSOR'S NOTE

Once again, the first answer you get in this calculation is the natural log of the occupancy forecast. In order to turn the natural log into an occupancy figure, you use the 2nd function of the LN key (e^x) on your BA II Plus: enter 13.3103 and press [2nd] e^x = 603,378.52.



MODULE QUIZ 2.4

Use the following information to answer Questions 1 through 3.

Regression Results for Monthly Cash Flow Study

	Coefficients	Standard Error	t-Statistic	p-Value
Intercept	26.8625	12.15146	2.210639	0.035719
Lag 1	0.7196	0.042584	16.89837	< 0.0001
Autocorrelation of the Residual				
Lag	Autocorrelation	Standard Error	t-Statistic	p-Value
12	-0.0254	0.0632	-0.4019	0.5612

- The number of observations in the time series used to estimate the model represented in the table is *closest* to:
 - 16.
 - 50.
 - 250.
- Based on the information given, what type of model was used?
 - AR(1).
 - AR(2).
 - AR(12).
- At a 5% level of significance, does the information indicate the presence of seasonality?
 - No, because the lag-12 autocorrelation of the residual is not significant.
 - Yes, because the lag-12 autocorrelation of the residual is significantly different than one.
 - There is not enough information provided; the autocorrelation for the first lag is also needed to detect seasonality.
- A time-series model that uses quarterly data exhibits seasonality if the fourth autocorrelation of the error term:
 - differs significantly from 0.
 - does not differ significantly from 0.
 - does not differ significantly from the first autocorrelation of the error term.
- In an autoregressive time-series model, seasonality may be corrected by:
 - excluding one or more of the lagged variables until the seasonality disappears.
 - transforming the time series using first-differencing.
 - adding an additional variable that reflects an appropriate lag of the time series.
- Which of the following AR models is *most appropriate* for a time series with annual seasonality using quarterly observations?
 - $b_1x_{t-1} + b_2x_{t-12} + \varepsilon_t$.
 - $b_0 + b_1x_{t-1} + b_2x_{t-4} + \varepsilon_t$.
 - $b_0 + b_1x_{t-4} + b_2x_{t-12} + \varepsilon_t$.

MODULE 2.5: ARCH AND MULTIPLE TIME SERIES



Video covering this content is available online.

LOS 2.m: Explain autoregressive conditional heteroskedasticity (ARCH) and describe how ARCH models can be applied to predict the variance of a time series.

When examining a single time series, such as an AR model, **autoregressive conditional heteroskedasticity (ARCH)** exists if the variance of the residuals in one period is *dependent* on the variance of the residuals in a previous period. When this condition exists, the standard errors of the regression coefficients in AR models and the hypothesis tests of these coefficients are invalid.

Using ARCH Models

An **ARCH model** is used to test for autoregressive conditional heteroskedasticity. Within the ARCH framework, an ARCH(1) time series is one for which the variance of the residuals in one period is dependent on (i.e., a function of) the variance of the residuals in the preceding period. To test whether a time series is ARCH(1), the squared residuals from an estimated time-series model, $\hat{\varepsilon}_t^2$ are regressed on the first lag of the squared residuals $\hat{\varepsilon}_{t-1}^2$.

The ARCH(1) regression model is expressed as:

$$\hat{\varepsilon}_t^2 = a_0 + a_1\hat{\varepsilon}_{t-1}^2 + \mu_t$$

where a_0 is the constant and μ_t is an error term.

If the coefficient, a_1 , is statistically different from zero, the time series is ARCH(1).

If a time-series model has been determined to contain ARCH errors, regression procedures that correct for heteroskedasticity, such as *generalized least squares*, must be used in order to develop a predictive model. Otherwise, the standard errors of the model's coefficients will be incorrect, leading to invalid conclusions.

Predicting the Variance of a Time Series

However, if a time series has ARCH errors, an ARCH model can be used to predict the variance of the residuals in future periods. For example, if the data exhibit an ARCH(1) pattern, the ARCH(1) model can be used in period t to predict the variance of the residuals in period $t + 1$:

$$\hat{\sigma}_{t+1}^2 = \hat{a}_0 + \hat{a}_1 \hat{\epsilon}_t^2$$

Example: ARCH(1) time series

The next figure contains the results from the regression of an ARCH(1) model. The squared errors for periods t through T are regressed on the squared errors for periods $t - 1$ through $T - 1$. (μ_t is the error term for the model.) Determine whether the results indicate autoregressive conditional heteroskedasticity (ARCH), and if so, calculate the predicted variance of the error terms in the next period if the current period squared error is 0.5625.

ARCH (1) Regression Results

Model: $\hat{\epsilon}_t^2 = a_0 + a_1 \hat{\epsilon}_{t-1}^2 + \mu_t$	Coefficients	Standard Error	t-Statistic	p-Value
Constant	5.9068	1.08631	5.4375	< 0.001
Lag 1	0.4515	0.09558	4.7238	< 0.001

Answer:

Since the p -value for the coefficient on the lagged variable indicates statistical significance, we can conclude that the time series is ARCH(1). As such, the variance of the error term in the next period can be computed as:

$$\hat{\sigma}_{t+1}^2 = \hat{a}_0 + \hat{a}_1 \hat{\epsilon}_t^2 = 5.9068 + 0.4515(0.5625) = 6.1608$$



PROFESSOR'S NOTE

If the coefficient a_1 is zero, the variance is constant from period to period. If a_1 is greater than (less than) zero, the variance increases (decreases) over time (i.e., the error terms exhibit heteroskedasticity).

LOS 2.n: Explain how time-series variables should be analyzed for nonstationarity and/or cointegration before use in a linear regression.

Occasionally an analyst will run a regression using two time series (i.e., time series utilizing two different variables). For example, using the market model to estimate the equity beta for a stock, an analyst regresses a time series of the stock's returns (y_t) on a time series of returns for the market (x_t):

$$y_t = b_0 + b_1 x_t + \epsilon_t$$

Notice that now we are faced with two different time series (y_t and x_t), either or both of which could be subject to nonstationarity.

To test whether the two time series have unit roots, the analyst first runs separate DF tests with five possible results:

1. Both time series are covariance stationary.
2. Only the dependent variable time series is covariance stationary.
3. Only the independent variable time series is covariance stationary.
4. Neither time series is covariance stationary and the two series *are not* cointegrated.
5. Neither time series is covariance stationary and the two series *are* cointegrated.

In Scenario 1 the analyst can use linear regression, and the coefficients should be statistically reliable, but regressions in Scenarios 2 and 3 will not be reliable. Whether linear regression can be used in Scenarios 4 and 5 depends upon whether the two time series are *cointegrated*.

Cointegration

Cointegration means that two time series are economically linked (related to the same macro variables) or follow the same trend and that relationship is not expected to change. If two time series are cointegrated, the error term from regressing one on the other is covariance stationary and the *t*-tests are reliable. This means that Scenario 5 will produce reliable regression estimates, whereas Scenario 4 will not.

To test whether two time series are cointegrated, we regress one variable on the other using the following model:

$$y_t = b_0 + b_1x_t + \varepsilon$$

where:

y_t = value of time series *y* at time *t*

x_t = value of time series *x* at time *t*

The residuals are tested for a unit root using the **Dickey-Fuller** test with critical *t*-values calculated by **Engle and Granger** (i.e., the DF–EG test). If the test rejects the null hypothesis of a unit root, we say the error terms generated by the two time series are covariance stationary and the two series are cointegrated. If the two series are cointegrated, we can use the regression to model their relationship.



PROFESSOR'S NOTE

For the exam, remember that the Dickey-Fuller test does not use the standard critical *t*-values we typically use in testing the statistical significance of individual regression coefficients. The DF–EG test further adjusts them to test for cointegration. As with the DF test, you do not have to know critical *t*-values for the DF–EG test. Just remember that like the regular DF test, if the null is rejected, we say the series (of error terms in this case) is covariance stationary and the two time series are cointegrated.

Figure 2.2: Can Linear Regression Be Used to Model the Relationship Between Two Time Series?

		<i>Independent Variable Time Series</i>	
		<i>Is Covariance Stationary</i>	<i>Is NOT Covariance Stationary</i>
<i>Dependent Variable Time Series</i>	<i>Is Covariance Stationary</i>	Yes	No
	<i>Is NOT Covariance Stationary</i>	No	Yes, IF the two time series are cointegrated

LOS 2.o: Determine an appropriate time-series model to analyze a given investment problem and justify that choice.

To determine what type of model is best suited to meet your needs, follow these guidelines:

1. Determine your goal.
 - Are you attempting to model the relationship of a variable to other variables (e.g., cointegrated time series, cross-sectional multiple regression)?
 - Are you trying to model the variable over time (e.g., trend model)?
2. If you have decided on using a time series analysis for an individual variable, plot the values of the variable over time and look for characteristics that would indicate nonstationarity, such as non-constant variance (heteroskedasticity), non-constant mean, seasonality, or structural change.

A **structural change** is indicated by a significant *shift* in the plotted data at a point in time that seems to divide the data into two or more distinct patterns. (Figure 2.3 shows a data plot that indicates a structural shift in the time series at Point a.) In this example, you have to run two different models, one incorporating the data before and one after that date, and test whether the time series has actually shifted. If the time series has shifted significantly, a single time series encompassing the entire period (i.e., both patterns) will likely produce unreliable results.

Figure 2.3: A Structural Shift in a Time Series

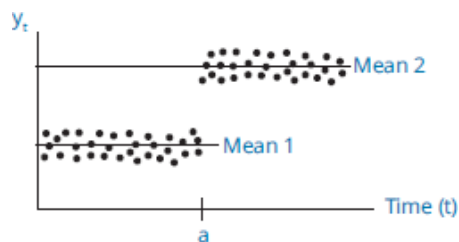

3. If there is no seasonality or structural shift, use a trend model.
 - If the data plot on a straight line with an upward or downward slope, use a linear trend model.
 - If the data plot in a curve, use a log-linear trend model.
4. Run the trend analysis, compute the residuals, and test for serial correlation using the Durbin-Watson test.
 - If you detect no serial correlation, *you can use the model*.
 - If you detect serial correlation, you must use another model (e.g., AR).
5. If the data has serial correlation, reexamine the data for stationarity before running an AR model. If it is not stationary, treat the data for use in an AR model as follows:
 - If the data has a linear trend, first-difference the data.
 - If the data has an exponential trend, first-difference the natural log of the data.
 - If there is a structural shift in the data, run two separate models as discussed previously.
 - If the data has a seasonal component, incorporate the seasonality in the AR model as discussed in the following.
6. After first-differencing in 5 previously, if the series is covariance stationary, run an AR(1) model and test for serial correlation and seasonality.
 - If there is no remaining serial correlation, *you can use the model*.
 - If you still detect serial correlation, incorporate lagged values of the variable (possibly including one for seasonality—e.g., for monthly data, add the 12th lag of the time series) into the AR model until you have removed (i.e., modeled) any serial correlation.

7. Test for ARCH. Regress the square of the residuals on squares of lagged values of the residuals and test whether the resulting coefficient is significantly different from zero.
- If the coefficient is not significantly different from zero, *you can use the model*.
 - If the coefficient is significantly different from zero, ARCH is present. Correct using generalized least squares.
8. If you have developed two statistically reliable models and want to determine which is better at forecasting, calculate their out-of-sample RMSE.



MODULE QUIZ 2.5

1. Which of the following is true of modeling a time series that contains two or more distinct periods where the data is fundamentally different?
 - A. The optimal data sample period for estimating the time-series model can be calculated mathematically.
 - B. To most accurately estimate the time-series model, the entire available time series data set should be used as the sample period.
 - C. We have to fit two different models for each of the two distinct periods.
2. Which of the following indicates the presence of Autoregressive Conditional Heteroskedasticity (ARCH) in a time-series model?
 - A. The autocorrelations of the error terms are zero at all lags.
 - B. The variance of the current error depends on the variance of lagged errors.
 - C. The error term shows significant serial correlation at lag 1.
3. Linear regression is least appropriate for modeling the relationship between two time series when:
 - A. neither series has a unit root.
 - B. one of the time series has a unit root, the other does not.
 - C. both series have a unit root, and the time series are cointegrated.

KEY CONCEPTS

LOS 2.a

A time series is a set of observations for a variable over successive periods of time. A time series model captures the time series pattern and allows us to make predictions about the variable in the future.

LOS 2.b

A simple linear trend model is: $y_t = b_0 + b_1t + \epsilon_t$, estimated for $t = 1, 2, \dots, T$.

A log-linear trend model, $\ln(y_t) = b_0 + b_1t + \epsilon_t$, is appropriate for exponential data.

A plot of the data should be used to determine whether a linear or log-linear trend model should be used.

The primary limitation of trend models is that they are not useful if the residuals exhibit serial correlation.

LOS 2.c

A time series is covariance stationary if its mean, variance, and covariances with lagged and leading values do not change over time. Covariance stationarity is a requirement for using AR models.

LOS 2.d

Autoregressive time series multiperiod forecasts are calculated in the same manner as those for other regression models, but since the independent variable consists of a lagged variable, it is necessary to calculate a one-step-ahead forecast before a two-step-ahead forecast may be calculated. The calculation of successive forecasts in this manner is referred to as the chain rule of forecasting.

A one-period-ahead forecast for an AR(1) would be determined in the following manner:

$$\hat{x}_{t+1} = \hat{b}_0 + \hat{b}_1 x_t$$

A two-period-ahead forecast for an AR(1) would be determined in the following manner:

$$\hat{x}_{t+2} = \hat{b}_0 + \hat{b}_1 \hat{x}_{t+1}$$

LOS 2.e

When an AR model is correctly specified, the residual terms will not exhibit serial correlation. If the residuals possess some degree of serial correlation, the AR model that produced the residuals is not the best model for the data being studied and the regression results will be problematic. The procedure to test whether an AR time-series model is correctly specified involves three steps:

1. Estimate the AR model being evaluated using linear regression.
2. Calculate the autocorrelations of the model's residuals.
3. Test whether the autocorrelations are significant.

LOS 2.f

A time series is mean reverting if it tends towards its mean over time. The mean

reverting level for an AR(1) model is $\frac{b_0}{(1-b_1)}$.

LOS 2.g

In-sample forecasts are made *within* the range of data used in the estimation. Out-of-sample forecasts are made *outside* of the time period for the data used in the estimation.

The root mean squared error criterion (RMSE) is used to compare the accuracy of autoregressive models in forecasting out-of-sample values. A researcher may have two autoregressive (AR) models, both of which seem to fit the data: an AR(1) model and an AR(2) model. To determine which model will more accurately forecast future values, we calculate the square root of the mean squared error (RMSE). The model with the lower RMSE for the out-of-sample data will have lower forecast error and will be expected to have better predictive power in the future.

LOS 2.h

Most economic and financial time series data are not stationary. The degree of the nonstationarity depends on the length of the series and changes in the underlying economic environment.

LOS 2.i

A random walk time series is one for which the value in one period is equal to the value in another period, plus a random error. A random walk process does not have a mean reverting level and is not stationary.

LOS 2.j

A time series has a unit root if the coefficient on the lagged dependent variable is equal to one. A series with a unit root is not covariance stationary. Economic and finance time series frequently have unit roots. Data with a unit root must be first differenced before being used in a time series model.

LOS 2.k

To determine whether a time series is covariance stationary, we can (1) run an AR model and/or (2) perform the Dickey-Fuller test.

LOS 2.l

Seasonality in a time series is tested by calculating the autocorrelations of error terms. A statistically significant lagged error term corresponding to the periodicity of the data indicates seasonality. Seasonality can be corrected by incorporating the appropriate seasonal lag term in an AR model.

If a seasonal lag coefficient is appropriate and corrects the seasonality, the AR model with the seasonal terms will have no statistically significant autocorrelations of error terms.

LOS 2.m

ARCH is present if the variance of the residuals from an AR model are correlated across time. ARCH is detected by estimating $\hat{\epsilon}_t^2 = a_0 + a_1 \hat{\epsilon}_{t-1}^2 + \mu_t$. If a_1 is significant, ARCH exists and the variance of errors can be predicted using: $\hat{\sigma}_{t+1}^2 = \hat{a}_0 + \hat{a}_1 \hat{\epsilon}_t^2$.

LOS 2.n

When working with two time series in a regression: (1) if neither time series has a unit root, then the regression can be used; (2) if only one series has a unit root, the regression results will be invalid; (3) if both time series have a unit root and are cointegrated, then the regression can be used; (4) if both time series have a unit root but are not cointegrated, the regression results will be invalid.

The Dickey-Fuller test with critical t -values calculated by Engle and Granger is used to determine whether two time series are cointegrated.

LOS 2.o

The RMSE criterion is used to determine which forecasting model will produce the most accurate forecasts. The RMSE equals the square root of the average squared error.

ANSWER KEY FOR MODULE QUIZZES

Module Quiz 2.1

- A** With a trend model, the independent variable is time, t . (LOS 2.b)
- A** The slope coefficient (b_1) is positive and significantly different from zero indicating an upward trend. (LOS 2.a)
- A** The t -statistic to test the statistical significance of the intercept and slope coefficient is the parameter estimate divided by its standard error. We reject the null hypothesis and conclude the coefficients are statistically significant if the absolute value of the t -statistic is greater than the two-tail 5% critical t -value with 43 degrees of freedom, which is 2.02.

$$t_{b_0} = \frac{1,195.6241}{8.9704362} = 133.3$$

$$t_{b_1} = \frac{12.230448}{0.3396171} = 36.0$$

Both the intercept term and the slope coefficient are significantly different from zero at the 5% level because both t -statistics are greater than the critical t -value of 2.02. (LOS 2.a)

- C** $\hat{Y}_{46} = \$1,195.6241 + \$12.230448(46) = \$1,758.225$ billion
(LOS 2.a)
- B** A log-linear model (choice B) is most appropriate for a time series that grows at a relatively constant growth rate. Neither a linear trend model (choice A), nor an AR(1) model (choice C) are appropriate in this case. (LOS 2.b)

Module Quiz 2.2

- B** Time series X has a definite upward trend, which once again suggests the expected value of the time series X is not constant, and therefore it is not covariance stationary. (LOS 2.c)

- B** Given

$$x_{t-1} = 16.5, \hat{x}_t = 5 + 1.75(16.5) = 33.875. \text{ So, } \hat{x}_{t+1} = 5 + 1.75\hat{x}_t = 5 + 1.75(33.875) = 64.28. \text{ So, } \hat{x}_{t+2} = 5 + 1.75\hat{x}_{t+1} = 5 + 1.75(64.28) = 117.49$$

(LOS 2.d)

- B** Out-of-sample performance is the most important indicator of a model's real-world forecasting ability. In-sample forecast performance is less persuasive, because forecasting the past is not difficult. The residuals from the fitted time-series model are another name for the model's in-sample forecast errors. (LOS 2.g)

Module Quiz 2.3

- A** The independent variable is the dependent variable lagged one period, so the model is an AR(1) model. (Module 2.2, LOS 2.d)
- C** The first-differenced series usually does not have a unit root and is, therefore, covariance stationary. (Module 2.3, LOS 2.j)
- A** All random-walk time series have a unit root. Time series with unit root do not have a finite mean-reverting level. (Module 2.3, LOS 2.i)
- A** A random walk process does not have a finite mean-reverting level and hence covariance nonstationary. An AR(1) model cannot be used to fit a covariance nonstationary time series. (Module 2.3, LOS 2.j)
- C** For a unit root test, the null hypothesis is that the time series has a unit root. For testing for unit roots, the Dickey-Fuller (DF) test computes the conventional t -statistic, which is then compared against the revised set of critical values computed by DF. If the test statistic is significant, we reject the null hypothesis (that the time series has a unit root), implying that a unit root is not present. (Module 2.3, LOS 2.k)

Module Quiz 2.4

- C** The standard error of the estimated autocorrelations is $1/\sqrt{T}$, where T is the number of observations (periods). So, if the standard error is given as 0.0632, the number of observations, T , in the time series must be $(1 / 0.0632)^2 \approx 250$. (Module 2.2, LOS 2.e)
- A** The results in the table indicate that the prediction equation is $x_t = 26.8625 + 0.7196x_{t-1}$, which is estimated from an AR(1) model. (Module 2.1 LOS 2.a)
- A** The autocorrelation in the twelfth month is not statistically different from zero. (p -value: $0.5612 > 0.05$) Thus, there appears to be no seasonality. (Module 2.4, LOS 2.l)
- A** If the fourth autocorrelation of the error term differs significantly from 0, this is an indication of seasonality. (Module 2.4, LOS 2.l)
- C** Adding an appropriate lag is an appropriate solution to seasonality. Excluding variables can sometimes be used to solve multicollinearity. Transforming using first-differencing can be a cure for nonstationarity. (Module 2.4, LOS 2.l)
- B** The seasonal (annual) lag occurs on a quarterly basis, so the appropriate model is $b_0 + b_1x_{t-1} + b_2x_{t-4} + \epsilon_t$. The intercept b_0 should be included in the model. (Module 2.4, LOS 2.l)

Module Quiz 2.5

- C** To accurately model a time series that contains shifts, it may be necessary to strategically choose a longer or shorter sample period, or to use a first- or second-order autoregressive model. There is no accepted formula for estimating the optimal sample period (though a graphical inspection of the data may be helpful). (LOS 2.o)

2. **B** ARCH is present when the variance of the error depends on the variance of previous errors. A zero autocorrelation of the error term at all lags suggests that an autoregressive model is a good fit to the data. (LOS 2.m)
3. **B** If only one time series has a unit root, we should not use linear regression. If neither time series have unit root, or if both time series have unit root and the time series are cointegrated, linear regression is appropriate to use. (LOS 2.n)

READING 3

MACHINE LEARNING

EXAM FOCUS

This topic review discusses the terminology used in advanced statistical models collectively referred to as machine learning. Be familiar with this terminology and the different types of models, their applications in investment decision-making, and their limitations. Specifically, be able to identify the appropriate algorithm that is most suitable for a given problem.

MACHINE LEARNING

The statistical models we have discussed so far rely on a set of assumptions about the distribution of the underlying data. **Machine learning (ML)** requires no such assumptions. Very broadly, ML is defined as the use of algorithms to make decisions by generalizing (or finding patterns) in a given data set. ML performs better than standard statistical approaches when dealing with a large number of variables (high dimension) and when the relationships are nonlinear.

ML terms are as follows:

- **Target variable.** This is the dependent variable (i.e., the y variable). Target variables can be continuous, categorical, or ordinal.
- **Features.** These are the independent variables (i.e., the x variables).
- **Training data set.** This is the sample used to fit the model.
- **Hyperparameter.** This is a model input specified by the researcher.

MODULE 3.1: TYPES OF LEARNING AND OVERFITTING PROBLEMS



Video covering this content is available online.

LOS 3.a: Describe supervised machine learning, unsupervised machine learning, and deep learning.

Supervised learning uses labeled training data (i.e., the target variable is defined) to guide the ML program toward superior forecasting accuracy. To identify earnings manipulators, for example, a large collection of attributes could be provided for known manipulators and for known nonmanipulators. A computer program could then be used to identify patterns that identify manipulators in another data set. Multiple regression (discussed in an earlier topic review) is an example of supervised learning. Typical tasks for supervised learning include classification and regression. If the target variable is continuous, the model

involved is a regression model. Classification models are used in cases where the target variable is categorical or ordinal (e.g., ranking). Algorithms can be designed for binary classification (e.g., classifying companies as likely to default vs. not likely to default) or multiclass classification (e.g., a ratings class for bonds).

In **unsupervised learning**, the ML program is not given labeled training data; instead, inputs (i.e., features) are provided without any conclusions about those inputs. In the absence of any target variable, the program seeks out structure or interrelationships in the data. Clustering is an example of an unsupervised ML program.

Deep learning algorithms are used for complex tasks such as image recognition, natural language processing, and so on. Programs that learn from their own prediction errors are called **reinforced learning** algorithms. Both of these kinds of algorithms are based on **neural networks**, a group of ML algorithms applied to problems with significant nonlinearities. We will discuss these kinds of algorithms in detail in a later LOS.

Figure 3.1 summarizes the suitability of various ML algorithms.

Figure 3.1: ML Algorithm Types

Variables	ML Algorithm Type	
	Supervised (Target Variable)	Unsupervised (No Target Variable)
Continuous	Regression	Dimensionality Reduction
	■ Linear; Penalized Regression/LASSO	■ Principal Components Analysis (PCA)
	■ Logistic	Clustering
Categorical	■ Classification and Regression Tree (CART)	■ K-Means
	■ Random Forest	■ Hierarchical
	Classification	Dimensionality Reduction
Continuous or Categorical	■ Logistic	■ Principal Components Analysis (PCA)
	■ Support Vector Machine (SVM)	Clustering
	■ K-Nearest Neighbor (KNN)	■ K-Means
Continuous or Categorical	■ Classification and Regression Tree (CART)	■ Hierarchical
	Neural Networks	Neural Networks
	Deep Learning	Deep Learning
	Reinforcement Learning	Reinforcement Learning

Reproduced from Level II CFA Curriculum learning module “Machine Learning,” Exhibit 2, with permission from CFA Institute.

Figure 3.2 shows the steps involved in selecting the appropriate ML algorithm to use, based on the problem to be solved and the characteristics of the data.

Figure 3.2: Choice of Appropriate ML Algorithm

- Step 1:* Decide if the data set is complex (too many features). If so, apply a dimension reduction algorithm before proceeding to step 2.
- Step 2:* Decide if the problem is that of classification. If yes, go to step 3. If no, (i.e., it is a numerical prediction problem):
- Use penalized regression if the data is linear.
 - Or, for nonlinear and complex data, use CART, random forests, or neural networks.
- Step 3:* Is it supervised classification? If no, go to step 4. For supervised classification:
- For linear data, use KNN or SVM.
 - For complex nonlinear data, use CART, random forests, or neural networks.
- Step 4:* For unsupervised classification:
- For linear data, use *k*-means if the number of categories is known. If the number of categories is not known, use hierarchical clustering.
 - For complex nonlinear data, use neural networks.

We will discuss these ML algorithms in the remainder of this topic review.

LOS 3.b: Describe overfitting and identify methods of addressing it.

Overfitting is an issue with supervised ML that results when a large number of features (i.e., independent variables) are included in the data sample. Overfitting has occurred when the noise in the target variables seems to improve the model fit (i.e., randomness is misperceived to be a pattern, resulting in high in-sample R-squared). Overfitting the model will decrease the accuracy of model forecasts on other (out-of-sample) data—overfit models do not **generalize** well to new data (i.e., out-of-sample R-squared will be low).



PROFESSOR'S NOTE

When a model generalizes well, it means that the model retains its explanatory power when it is applied to new (i.e., out-of-sample) data.

To measure how well a model generalizes, data analysts create three nonoverlapping data sets: (1) **training sample** (used to develop the model), (2) **validation sample** (used for tuning the model), and (3) **test sample** (used for evaluating the model using new data). In-sample prediction errors occur with the training and validation samples, while prediction errors in the test sample are known as the out-of-sample error. Data scientists then decompose these errors into the following:

- **Bias error.** This is the in-sample error resulting from models with a poor fit.
- **Variance error.** This is the out-of-sample error resulting from overfitted models that do not generalize well.
- **Base error.** These are residual errors due to random noise.

A **learning curve** plots the accuracy rate (i.e., $1 - \text{error rate}$) in the validation or test sample versus the size of the training sample. A robust, well-generalizing model will show an improving accuracy rate as the sample size is increased, and the in-sample and out-of-sample error rates will converge toward a *desired* accuracy level, as shown in the third panel of Figure 3.3. Models with high bias error (first panel) will see the error rates converge, but far below the desired level. Models with high variance error (second panel)

will see only the in-sample accuracy rate converge toward the desired level, while the out-of-sample accuracy rate lags far behind.

Figure 3.3: Accuracy Rate Patterns

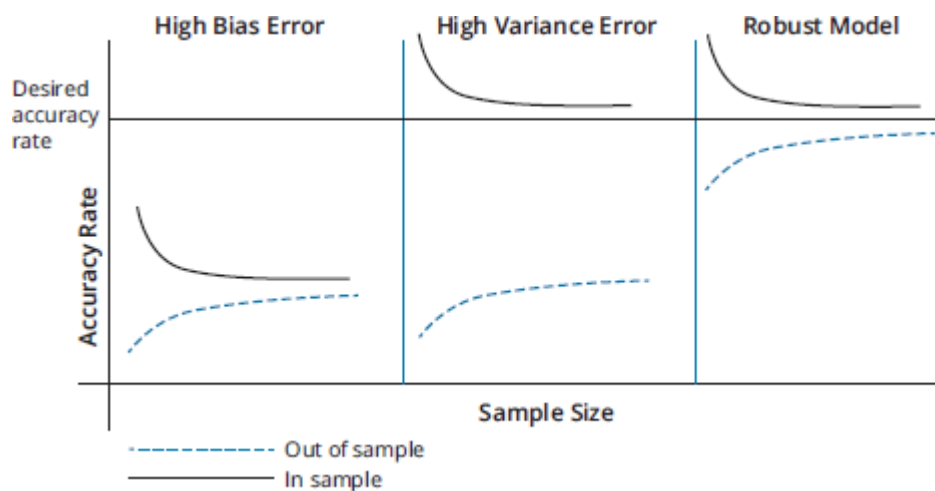

Variance error increases with model complexity, while bias error decreases with complexity. Typically, linear models tend to have high bias error while nonlinear models tend to have high variance error. Data scientists often express this as a tradeoff between *cost* and *complexity*. An optimal level of complexity minimizes the total error and is a key part of successful model generalization.

To reduce the problem of overfitting, data scientists use complexity reduction and cross validation. In complexity reduction, a penalty is imposed to exclude features that are not meaningfully contributing to out-of-sample prediction accuracy. This penalty value increases with the number of independent variables (features) used by the model.

For a model to learn sufficiently, researchers must ensure that the training data set is both large and representative of the population. The validation sample, similarly, should be large and representative to properly test the model. A sampling technique known as **cross validation** estimates out-of-sample error rates directly from the validation sample.

In a **k-fold cross validation**, the sample is randomly divided equally into k parts. The training sample comprises $(k - 1)$ parts, with one part left for validation. Error is then measured for the model in each of the parts. This process is repeated k times, and the average in-sample and out-of-sample error rates are compiled.



MODULE QUIZ 3.1

1. Which statement about target variables is *most accurate*?
 - A. They can be continuous, ordinal, or categorical.
 - B. They are not specified for supervised learning.
 - C. They refer to independent variables.
2. Which statement *most accurately* describes supervised learning?
 - A. It uses labeled training data.
 - B. It requires periodic human intervention.
 - C. It is best suited for classification.
3. A model that has poor in-sample explanatory power is *most likely* to have a high:
 - A. bias error.

- B. variance error.
 - C. base error.
4. The problem of overfitting a model would *least appropriately* be addressed by:
- A. imposing a penalty on included features that do not add to explanatory power of the model.
 - B. using cross validation.
 - C. using a smaller sample.
5. Cross validation occurs when:
- A. training and validation samples change over the learning cycle.
 - B. prediction is tested in another heterogeneous sample.
 - C. the performance parameter is set by another algorithm.

MODULE 3.2: SUPERVISED LEARNING ALGORITHMS



Video covering this content is available online.

LOS 3.c: Describe supervised machine learning algorithms—including penalized regression, support vector machine, k-nearest neighbor, classification and regression tree, ensemble learning, and random forest—and determine the problems for which they are best suited.

We will now describe some of the common supervised ML algorithms and their applications:

1. **Penalized regressions.** Penalized regression models reduce the problem of overfitting by imposing a penalty based on the number of features used by the model. The penalty value increases with the number of independent variables (features) used. Imposing such a penalty can exclude features that are not meaningfully contributing to out-of-sample prediction accuracy (i.e., it makes the model more parsimonious). Penalized regression models seek to minimize the sum of square errors (SSE) *as well as* a penalty value.

Least absolute shrinkage and selection operator (LASSO). This is a popular penalized regression model. In addition to minimizing SSE, LASSO minimizes the sum of the absolute values of the slope coefficients. In such a framework, there is a tradeoff between reducing the SSE (by increasing the number of features) and the penalty imposed on the inclusion of more features. Through optimization, LASSO automatically eliminates the least predictive features. A penalty term, λ (lambda), is the hyperparameter that determines the balance between overfitting the model and keeping it parsimonious.

A related method to reduce statistical variability in a high dimension data estimation problem is **regularization**. Regularization forces the beta coefficients of nonperforming features toward zero.

Investment analysts use LASSO to build parsimonious models. Regularization can be applied to nonlinear models, such as the estimation of a stable covariance matrix that can be used for mean-variance optimization.



PROFESSOR'S NOTE

In everyday usage, *parsimonious* means stingy or penny-pinching. In the world of statistics, a parsimonious model is one that accomplishes the required level of explanation using as few predictor variables as possible.

- 2. Support vector machine (SVM).** SVM is a linear classification algorithm that separates the data into one of two possible classifiers (e.g., sell vs. buy). Given n features, an n -dimensional hyperplane divides a sample into one of the two possible classifications. SVM maximizes the probability of making a correct prediction by determining the boundary that is farthest away from all the observations. This boundary comprises a discriminant boundary as well as margins on the side of the boundary. The margins are determined by the support vectors, observations that are closest to the boundary. Misclassified observations in the training data are handled via **soft margin classification**. This adaptation optimizes the tradeoff between a wider margin and classification error. We should note that a more complex, nonlinear model can be used for classification as opposed to SVM to reduce classification error, but this requires more features and may result in overfitting.

Applications of SVM in investment management include classifying debt issuers into likely-to-default versus not-likely-to-default issuers, stocks-to-short versus not-to-short, and even classifying text (from news articles or company press releases) as positive or negative.

- 3. K-nearest neighbor (KNN).** More commonly used in classification (but sometimes in regression), this technique is used to classify an observation based on *nearness* to the observations in the training sample. The researcher specifies the value of k , the hyperparameter, triggering the algorithm to look for the k observations in the sample that are closest to the new observation that is being classified. The specification of k is important because if it is too small, it will result in a high error rate, and if it is too large, it will dilute the result by averaging across too many outcomes. Also, if k is even, there may be ties, with no clear winner. KNN is a powerful, nonparametric model, but it requires a specification of what it means to be *near*. Analysts need to have a clear understanding of the data and the underlying business to be able to specify the distance metric that needs to be optimized. Another issue with KNN is the specification of feature set; inclusion of irrelevant or correlated features can skew the results.

Investment applications of KNN include predicting bankruptcy, assigning a bond to a ratings class, predicting stock prices, and creating customized indices.

- 4. Classification and regression trees (CART).** Classification trees are appropriate when the target variable is categorical, and are typically used when the target is binary (e.g., an IPO will be successful vs. not successful). Logit models, discussed in a previous reading, are also used when the target is binary, but are ill-suited when there are significant nonlinear relationships among variables. In such cases, classification trees may be a viable alternative. Regression trees are appropriate when the target is continuous. Classification trees assign observations to one of two possible classifications at each node. At the top of the tree, the top feature (i.e., the one most important in explaining the target) is selected, and a cutoff value c is estimated. Observations with feature values greater than c are assigned to one classification, and the remainder are assigned to the other classification. The resulting classes are then evaluated based on a second

feature, and again divided into one of two classes. Every successive classification should result in a lower estimation error than the nodes that preceded it. The tree stops when the error cannot be reduced further, resulting in a terminal node as shown in Figure 3.4.

Figure 3.4: Classification Tree Example

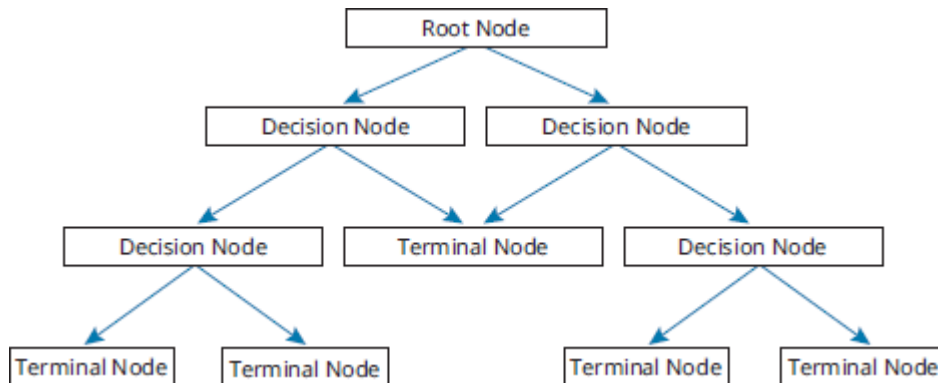

It should be noted that a feature may reappear in lower nodes of a tree with a different cutoff value if it helps in classification. The features and cutoff values are learned by the algorithm based on labeled training data.

To avoid overfitting, regularization criteria such as maximum tree depth, maximum number of decision nodes, and so on are specified by the researcher. Alternatively, sections of tree with minimal explanatory power are **pruned**.

CART is popular because it provides a visual explanation of the prediction process, compared to other algorithms that are often described as black boxes due to their opacity.

Investment applications of CART include detecting fraudulent financial statements and selecting stocks and bonds.

- 5. Ensemble and Random Forest.** Ensemble learning is the technique of combining predictions from multiple models rather than a single model. The ensemble method results in a lower average error rate because the different models cancel out noise. Two kinds of ensemble methods are used: aggregation of heterogeneous learners and aggregation of homogenous learners.

Under aggregation of heterogeneous learners, different algorithms are combined together via a **voting classifier**. The different algorithms each get a vote, and then we go with whichever answer gets the most votes. Ideally, the models selected will have sufficient diversity in approach, resulting in a greater level of confidence in the predictions.

Under aggregation of homogenous learners, the same algorithm is used, but on different training data. The different training data samples (used by the same model) can be derived by **bootstrap aggregating** or **bagging**. The process relies on generating random samples (bags) with replacement from the initial training sample.

Random forest is a variant of classification trees whereby a large number of classification trees are trained using data bagged from the same data set. A randomly selected subset of features is used in creating each tree, and each tree is slightly

different from the others. The process of using multiple classification trees to determine the final classification is akin to the practice of crowdsourcing. Because each tree only uses a subset of features, random forests can mitigate the problem of overfitting. Using random forests can increase the signal-to-noise ratio because errors across different trees tend to cancel each other out. A drawback of random forests is that the transparency of CART is lost, and we are back to the black-box category of algorithms.

Investment applications of random forest include factor-based asset allocation, and prediction models for the success of an IPO.



MODULE QUIZ 3.2

1. A general linear regression model that focuses on reduction of the total number of features used is *best* described as a:
 - A. clustering model.
 - B. deep learning model.
 - C. penalized regression model.
2. A machine learning technique that can be applied to predict either a categorical target variable or a continuous target variable is most likely to describe a:
 - A. support vector machine.
 - B. classification and regression tree (CART).
 - C. logit model.
3. An algorithm to assign a bond to a credit rating category is *least likely* to use:
 - A. clustering.
 - B. classification and regression tree (CART).
 - C. K-nearest neighbor (KNN).
4. A fixed-income analyst is designing a model to categorize bonds into one of five ratings classifications. The analyst uses 12 fundamental variables and 2 technical variables to help her in the task. The number of features used by the analyst is *closest* to:
 - A. 14 features.
 - B. 70 features.
 - C. 120 features.

MODULE 3.3: UNSUPERVISED LEARNING ALGORITHMS AND OTHER MODELS



Video covering this content is available online.

LOS 3.d: Describe unsupervised machine learning algorithms—including principal components analysis, k-means clustering, and hierarchical clustering—and determine the problems for which they are best suited.

We now discuss some of the following examples of unsupervised learning and their applications in the investment field:

1. **Principal component analysis (PCA).** Problems associated with too much noise often arise when the number of features in a data set (i.e., its dimension) is excessive. Dimension reduction seeks to reduce this noise by discarding those attributes that contain little information. One method is PCA, which summarizes the information in a large number of correlated factors into a much smaller set of uncorrelated factors. These uncorrelated factors, called **eigenvectors**, are linear combinations of the original features. Each eigenvector has an **eigenvalue**—the proportion of total variance in the

data set explained by the eigenvector. The first factor in PCA would be the one with the highest eigenvalue, and would represent the most important factor. The second factor is the second-most important (i.e., has the second-highest eigenvalue) and so on, up to the number of uncorrelated factors specified by the researcher. **Scree plots** show the proportion of total variance explained by each of the principal components. In practice, the smallest number of principal components that collectively capture 85%–95% of the total variance are retained. Since the principal components are linear combinations of the original data set, they cannot be easily labeled or interpreted, resulting in a black-box approach.

2. **Clustering.** Given a data set, *clustering* is the process of grouping observations into categories based on similarities in their attributes (called cohesion). For example, stocks can be assigned to different categories based on their past performance, rather than using standard sector classifiers (e.g., finance, healthcare, technology, etc.). In practice, human judgment plays a role in defining what is similar. Euclidian distance, the straight-line distance between two observations, is one common metric that is used. Common types of clustering include *k*-means clustering and hierarchical clustering.

K-means clustering partitions observations into *k* nonoverlapping clusters, where *k* is a hyperparameter (i.e., set by the researcher). Each cluster has a centroid (the center of the cluster), and each new observation is assigned to a cluster based on its proximity to the centroid. Initially, *k* centroids are randomly selected, and clustering starts. As a new observation gets assigned to a cluster, its centroid is recalculated, which may result in reassignment of some observations, thus resulting in a new centroid and so forth until all observations are assigned and no new reassignment is made. One limitation of this type of algorithm is that the hyperparameter *k* is chosen before clustering starts, meaning that one has to have some idea about the nature of the data set. K-means clustering is used in investment management to classify thousands of securities based on patterns in high dimensional data.

Hierarchical clustering builds a hierarchy of clusters without any predefined number of clusters. In an **agglomerative** (or bottom-up) **clustering**, we start with one observation as its own cluster and add other similar observations to that group, or form another nonoverlapping cluster. A **divisive** (or top-down) **clustering** algorithm starts with one giant cluster, and then it partitions that cluster into smaller and smaller clusters.

Clustering can be used in investment management for diversification by investing in assets from multiple clusters. Clustering can also be useful in analysis of portfolio risk, as concentration is evidenced by a large portfolio allocation to one cluster. While clusters are themselves not clearly labeled or defined, clustering can be valuable in uncovering hidden structures or similarities between observations in complex data sets.

EXAMPLE: Application of machine learning to ESG investing

ESG (environmental, social, and governance) factor-based investing is lately becoming popular owing to changes in investor preferences. The governance factor which focuses on corporate board actions in the interests of shareholders, can be objectively observed and measured. The social and environmental impact of a company's actions is more

subjective. Machine learning and artificial intelligence techniques can use natural language processors to parse through corporate disclosures in text, audio, and video formats to collate the information. For example, mentions of words such as “human capital,” “living wage,” and “D&I” can be collected to represent a company’s response to social responsibilities. Similarly, “sustainable,” “recycle,” “green,” and similar words could indicate the company’s intentions toward environmental goals.

Supervised learning algorithms such as logistic regression, SVM, CART, random forests, or neural networks can then be used to generate ESG scores.

LOS 3.e: Describe neural networks, deep learning nets, and reinforcement learning.

Neural Networks

Useful in supervised regression and classification models, **neural networks (NNs)**, (also called artificial neural networks, or ANNs) are constructed as nodes connected by links. The input layer consists of nodes with values for the features (independent variables). These values are scaled so that the information from multiple nodes is comparable and can be used to calculate a weighted average. The input values from the nodes in the input layer connect to a second set of nodes in the hidden layer. Typically, several inputs are connected to a particular hidden node, meaning that the node receives multiple input values via the links. The nodes that follow the input variables are called **neurons** because they process the input information. These neurons comprise a **summation operator** that collates the information (as a weighted average) and passes it on to a (typically nonlinear) **activation function**, to generate a value from the input values. This value is then passed forward to other neurons in subsequent hidden layers (a process called **forward propagation**). A related process, **backward propagation**, is employed to revise the weights used in the summation operator as the network learns from its errors.

There may be multiple hidden layers with linked nodes. The multiple links between the information in the input layer and multiple nodes in the hidden layers (each with its own activation function) allow the neural network to model complex, nonlinear functions. There is typically a single node in the output layer that is the prediction of the model.

The researcher must determine the structure of the network. For example, for a network with three inputs (features), we would have three nodes in the input layer. We might specify a single hidden layer with four nodes, in addition to an output layer with a single node. This structure—3, 4, and 1—is set by the researcher, and referred to as the hyperparameters of the neural network. Hyperparameters may be revised based on the out-of-sample performance of the model.

Deep Learning Networks (DLNs)

Deep learning networks (DLNs) are neural networks with many hidden layers (at least 2, but often more than 20). DLNs are often used for image, pattern, and character recognition. The last layer in a DLN calculates the expected probability of an observation

belonging to a category, and the observation is assigned to the category with the highest probability. Additional applications of DLNs include credit card fraud detection, autonomous cars, natural language processing, and investment decision-making.

In one study using the six input parameters of the Black-Scholes model, a DLN was able to predict option values with model R^2 of 99.8%. Other studies have used DLNs in investment decision-making using standard factors (e.g., book-to-market values, operating income to market capitalization) to beat strategies using standard factor models.

The popularity of DLNs can be linked to advances in analytical methods, increases in computing speed, and availability of large quantities of machine-readable data.

Reinforcement Learning (RL)

Reinforcement learning (RL) algorithms have an agent that seeks to maximize a defined reward given defined constraints. The RL agent does not rely on labeled training data, nor does it provide instantaneous feedback, but rather learns based on feedback from (millions of) trials. When applied to the ancient game of Go, DeepMind's AlphaGo algorithm was able to beat the reigning world champion. The efficacy of RL in investment decision-making is not yet conclusive.



MODULE QUIZ 3.3

1. Image recognition problems are *best* suited for which category of machine learning (ML) algorithms?
 - A. Hierarchical clustering.
 - B. Unsupervised learning.
 - C. Deep learning.
2. Which of the following is *least likely* to be described as a black-box approach to machine learning (ML)?
 - A. Principal component analysis (PCA).
 - B. Classification trees.
 - C. Random forests.
3. An analyst wants to categorize an investment universe of 1,000 stocks into 10 dissimilar groups. The machine learning (ML) algorithm most suited for this task is:
 - A. a classification and regression tree (CART).
 - B. clustering.
 - C. regression.

KEY CONCEPTS

LOS 3.a

In supervised learning, inputs and outputs are identified for the computer, and the algorithm uses this labeled training data to model relationships.

For unsupervised learning, the computer is not given labeled data; rather, it is provided unlabeled data that the algorithm uses to determine the structure of the data.

With deep learning algorithms, algorithms such as neural networks and reinforced learning learn from their own prediction errors, and they are used for complex tasks such as image

recognition and natural language processing.

LOS 3.b

In supervised learning, overfitting results from a large number of independent variables (features), resulting in an overly complex model that may have generalized random noise that improves in-sample forecasting accuracy. However, overfit models do not generalize well to new data (i.e., low out-of-sample R-squared).

To reduce the problem of overfitting, data scientists use complexity reduction and cross validation. In complexity reduction, a penalty is imposed to exclude features that are not meaningfully contributing to out-of-sample prediction accuracy. This penalty value increases with the number of independent variables used by the model.

LOS 3.c

Supervised learning algorithms include:

- Penalized regression. Reduces overfitting by imposing a penalty on and reducing the nonperforming features.
- Support vector machine (SVM). A linear classification algorithm that separates the data into one of two possible classifiers based on a model-defined hyperplane.
- K-nearest neighbor (KNN). Used to classify an observation based on nearness to the observations in the training sample.
- Classification and regression tree (CART). Used for classifying categorical target variables when there are significant nonlinear relationships among variables.
- Ensemble learning. Combines predictions from multiple models, resulting in a lower average error rate.
- Random forest. A variant of the classification tree whereby a large number of classification trees are trained using data bagged from the same data set.

LOS 3.d

Unsupervised learning algorithms include:

- Principal components analysis. Summarizes the information in a large number of correlated factors into a much smaller set of uncorrelated factors, called eigenvectors.
- K-means clustering. Partitions observations into k nonoverlapping clusters; a centroid is associated with each cluster.
- Hierarchical clustering. Builds a hierarchy of clusters without any predefined number of clusters.

LOS 3.e

Neural networks comprise an input layer, hidden layers (which process the input), and an output layer. The nodes in the hidden layer are called neurons, which comprise a summation operator (that calculates a weighted average) and an activation function (a nonlinear function).

Deep learning networks are neural networks with multiple hidden layers. DLNs are useful for pattern, speech, and image recognition.

Reinforcement learning (RL) algorithms seek to learn from their own errors, thus maximizing a defined reward.

ANSWER KEY FOR MODULE QUIZZES

Module Quiz 3.1

1. **A** Target variables (i.e., dependent variables) can be continuous, ordinal, or categorical. Target variables are not specified for unsupervised learning. (LOS 3.a)
2. **A** Supervised learning uses labeled training data, and it does not need human intervention. Classification algorithms can be used for both supervised and unsupervised learning. (LOS 3.a)
3. **A** Bias error is the in-sample error resulting from models with a poor fit. (LOS 3.b)
4. **C** To reduce the problem of overfitting, data scientists use complexity reduction and cross validation. In complexity reduction, a penalty is imposed to exclude features that are not meaningfully contributing to out-of-sample prediction accuracy. (LOS 3.b)
5. **A** In cross validation, the training and validation samples are randomly generated every learning cycle. (LOS 3.b)

Module Quiz 3.2

1. **C** Penalized regression imposes a penalty based on the number of features used in a model. Penalized regression is used to construct parsimonious models. (LOS 3.c)
2. **B** Classification and regression tree (CART) is a supervised machine learning technique that can be applied to predict either a continuous target variable (producing a regression tree), or a categorical target variable (producing a classification tree). CART is most commonly applied to binary classification or regression. Support vector machines and logit models are used only for categorical target variable. (LOS 3.c)
3. **A** CART and KNN are supervised learning algorithms used for classification. Clustering is an unsupervised learning algorithm (i.e., it does not use labeled training data for ratings such as AAA, AA, etc.) for grouping similar observations. (LOS 3.c)
4. **A** The analyst is using 12 fundamental variables and 2 technical variables for a total of 14 features. (LOS 3.c)

Module Quiz 3.3

1. **C** Deep learning algorithms are used for complex tasks such as image recognition and natural language processing. (LOS 3.e)
2. **B** Classification trees are popular because they provide a visual explanation of the predictive process. Random forests and PCA do not provide clear guidance about the features used to classify observations (random forests) or what the principal

components represent, resulting in the black-box descriptor for both algorithms. (LOS 3.c, 3.d)

3. **B** Since the researcher is not providing any labeled training data about the 1,000 stocks, we have to use an unsupervised learning algorithm. Both regression and CART are supervised learning algorithms. Clustering, an unsupervised learning algorithm, is suitable for this task. (LOS 3.c)

READING 4

BIG DATA PROJECTS

EXAM FOCUS

This topic review is a very broad overview of the usage of big data analysis for financial forecasting. Candidates should understand (1) the terminology used and the processes involved in big data projects, (2) the requirements and limitations of the techniques discussed, and (3) how to evaluate a model's performance.

INTRODUCTION

Big data is characterized by the three Vs of volume, variety, and velocity:

- *Volume* refers to the quantity of data. Big data refers to a huge volume of data.
- *Variety* refers to data sources. Big data is collected from various sources: user-generated, traditional transactional, emails, images, clickstreams, and so on. The collection of various data presents tremendous opportunities as well as concerns, such as privacy protection.
- *Velocity* refers to the speed with which the data is created and collected (e.g., all the social media postings created during a specified time interval).

When used for generating inferences, an additional characteristic, the **veracity** or validity of the data, needs to be considered. Not all data sources are reliable, and the researcher has to separate quality from quantity to generate robust forecasts.

Structured data (e.g., balance sheet data for companies) is neatly organized in rows and columns. **Unstructured data** (e.g., text from SEC filings) is unorganized, and the machine learning (ML) algorithm has to sift through the noise to pick out information.

MODULE 4.1: DATA ANALYSIS STEPS



Video covering this content is available online.

LOS 4.a: Identify and explain steps in a data analysis project.

To illustrate the steps involved in analyzing data for financial forecasting, we will use an example of a consumer credit scoring model in the following five steps:

1. *Conceptualization of the modeling task.* This step requires us to define the problem at hand, the output of the model, how the model will be used and for whom, and whether the model will be embedded in existing (or new) business processes. In our example, the purpose of the model is to accurately measure the credit risk for a borrower.

2. *Data collection*. For financial forecasting, usually structured, numeric data is collected from internal and external sources. Credit scoring models may use past repayment history, employment history, income, and other relevant variables about a borrower. The researcher has to determine which sources (internal or external) to use to collect this data.
3. *Data preparation and wrangling*. This step involves cleaning the data set and preparing it for the model. Cleaning the data set includes addressing any missing values or verification of any out-of-range values. Preprocessing data may involve aggregating, filtering, or extracting relevant variables. For the credit scoring model, rules may be used to fill in the gaps where data is either missing or deemed to be inaccurate.
4. *Data exploration*. This step involves feature selection and engineering as well as initial (i.e., exploratory) data analysis. In a credit scoring model, several variables may be combined to form an ability-to-pay score.
5. *Model training*. This step involves determining the appropriate ML algorithm to use, evaluating the algorithm using a training data set, and tuning the model. The choice of the model depends on the nature of the relationship between the features and the target variable.

These five steps are iterative. Depending on the quality of the output, the researcher can go back and tweak any of the steps involved to improve the model. For example, the researcher may revisit the data exploration step to reengineer the features selected for the model.

The steps involved need to be modified in order to analyze unstructured, text-based data. For example, suppose the researcher wants to also incorporate a borrower's social media posts in the determination of credit scores. The first four steps would then be modified as follows:

1. *Text problem formulation*. The analyst will determine the problem and identify the exact inputs and output of the model. The analyst also has to determine how the output will be used.
2. *Data collection (curation)*. This is determining the sources of data to be used (e.g., web scouring, specific social media sites). If using supervised learning, annotating a reliable target variable is also necessary (e.g., specifying which text is associated with negative or positive scoring of credit risk).
3. *Text preparation and wrangling*. This requires preprocessing the stream(s) of unstructured data to make it usable by traditional structured modeling methods.
4. *Text exploration*. This involves text visualization as well as text feature selection and engineering.

The output of a model using unstructured data may then be used in isolation, or combined with other structured variables as an input into another model.

LOS 4.b: Describe objectives, steps, and examples of preparing and wrangling data.

This critical step involves cleansing and organizing raw data for use in a model, and takes most of the project's time and resources. Once a problem is defined, appropriate data to

be collected is identified with the help of domain experts. Data collection involves downloading data from internal and external sources. While accessing a database, appropriate caution must be exercised to ensure data validity. **README files** associated with a database usually contain information about how, what, and where data is stored. External data can also be obtained from third-party vendors using an **application programming interface (API)**. External data comes with a price, but saves time and money in the data wrangling step. One issue with using external data in financial forecasting is that other market participants can use the same data, diminishing the firm's proprietary advantage.

Data cleansing deals with reducing errors in the raw data. For structured data, errors in raw data include:

- Missing values.
- Invalid values (i.e., data is outside of a meaningful range).
- Inaccurate values.
- Non-uniform values due to use of wrong format or unit of measurement.
- Duplicate observations.

Data cleansing is accomplished via automated, rules-based algorithms as well as human intervention. **Metadata** (summary data) for the raw data set may serve as a starting point for error identification. Observations with erroneous values that cannot be cleansed would be dropped.

Data wrangling involves preprocessing data for model use. Preprocessing includes data transformation and scaling.

Data transformation types include:

- Extraction (e.g., extracting number of years employed based on dates provided).
- Aggregation, which involves consolidating two related variables into one, using appropriate weights.
- Filtration, which involves removing irrelevant observations.
- Selection, which involves removing features (i.e., data columns) not needed for processing.
- Conversion of data of diverse types (e.g., nominal, ordinal).

Outliers in the data set can be identified via statistical techniques (e.g., any value further than three standard deviations from the mean) and replaced with algorithm-determined values. Alternatively, the observation may be deleted. One approach to removing outliers is known as **trimming**, whereby the highest and lowest $x\%$ of observations are excluded. In **winsorization**, extreme values may be replaced by the maximum value allowable for that variable.

Conversion of data features to a common unit of measurement is known as **scaling**. Some ML algorithms (e.g., neural networks, SVM) require features to be homogenous (i.e., feature values in the same range). Two common methods of scaling are **normalization** and **standardization**.

Normalization scales variable values between 0 and 1.

$$\text{normalized } X_i = \frac{X_i - X_{\min}}{X_{\max} - X_{\min}}$$

Standardization centers the variables at 0 and scales them as units of standard deviations from the mean.

$$\text{standardized } X_i = \frac{X_i - \mu}{\sigma}$$

A standardized variable has a normal distribution with a mean of 0 and a standard deviation of 1. A standardized variable value of +1.22 is interpreted as having a value of 1.22 standard deviations above its mean.

Unlike normalization, standardization is not sensitive to outliers, but assumes that the variable is normally distributed.



PROFESSOR'S NOTE

We present some of the LOS in this reading out of order for ease of exposition.

LOS 4.g: Describe preparing, wrangling, and exploring text-based data for financial forecasting.

Unstructured, text-based data is more suitable for human use rather than for processing by a computer. For analysis, unstructured data has to be converted into structured data. **Text processing** is the cleansing and preprocessing of text-based data.

Text Preparation or Cleansing

Text cleansing involves the following steps:

1. *Remove HTML tags.* Text collected from web pages has embedded HTML tags, which may need to be removed before processing. A **regular expression (regex)** is a text string used to identify characters in a particular order.
2. *Remove punctuations.* Text analysis usually does not need punctuations, so these need to be removed as well. Some punctuations (e.g., %, \$, ?) may be needed for analysis, and if so, they are replaced with annotations (i.e., textual expressions) for model training.
3. *Remove numbers.* Digits are removed or replaced with annotations to let the ML program know that a number is present, but its value is not important in the analysis. If the value of a number is important for analysis, such values are first extracted via text applications.
4. *Remove white spaces.* Extra formatting-related white spaces (e.g., tabs, indents) do not serve any purpose in text processing and are removed.

Text Wrangling (Preprocessing)

Cleansed text is then normalized using the following steps:

1. *Lowercasing.* So as to not discriminate between *market* and *Market*.

2. *Removal of stop words.* In some ML applications, stop words such as *the*, *is*, and so on do not carry any semantic meaning; hence, they are removed to reduce the number of tokens in the training data.
3. *Stemming.* This is a rules-based algorithm that converts all variations of a word into a common value. For example, *integrate*, *integration*, and *integrating* are all assigned a common value of *integrat*. While stemming makes the text confusing for human processing, it is ideally suited for machines.
4. *Lemmatization.* This involves the conversion of inflected forms of a word into its *lemma* (i.e., morphological root). Lemmatization is similar to stemming, but is more computationally advanced and resource intensive.

In text wrangling, a **token** is a word, and **tokenization** is the process of splitting a sentence into tokens. For example, consider the sentence, “It is a beautiful day.” This may be assigned five tokens: (1) it, (2) is, (3) a, (4) beautiful, and (5) day.

After the data is cleansed and normalized, a **bag-of-words (BOW)** procedure is applied, which simply collects all the words or tokens without regard to the sequence of occurrence. A **document term matrix** is then used to convert the unstructured data into structured data. In this matrix, each text document is a row, and the columns are represented by tokens. The cell value represents the number of occurrences of a token in a document (i.e., row).

If the sequence of text is important, **N-grams** can be used to represent word sequences. A two-word sequence is a bigram, a three-word sequence is trigram, and so forth. Consider the sentence, “The market is up today.” Bigrams of this sentence include “the_market,” “market_is,” “is_up,” and “up_today.” BOW is then applied to the bigrams instead of the original words. N-gram implementation will affect the normalization of the BOW because stop words will not be removed.



MODULE QUIZ 4.1

1. Which of the following is *least likely* to be a step in data analysis?
 - A. Structured formative analysis.
 - B. Data collection.
 - C. Data preparation.
2. Which of the following shortcomings of a feature is *least likely* to be addressed by data cleansing?
 - A. Missing values.
 - B. Common values.
 - C. Non-uniform values.
3. The process of adjusting variable values so that they fall between 0 and 1 is *most commonly* referred to as:
 - A. scaling.
 - B. standardization.

MODULE 4.2: DATA EXPLORATION



Video covering this content is available online.

LOS 4.d: Describe objectives, methods, and examples of data exploration.

Data exploration seeks to evaluate the data set and determine the most appropriate way to configure it for model training.

Steps in data exploration include the following:

1. **Exploratory data analysis (EDA)** involves looking at data descriptors such as summary statistics, heat maps, word clouds, and so on. The objectives of EDA include:
 - Understanding data properties, distributions, and other characteristics.
 - Finding patterns or relationships, and evaluating basic questions and hypotheses.
 - Planning modeling in future steps.
2. **Feature selection** is a process to select only the needed attributes of the data for ML model training. The higher the number of features selected, the higher the model complexity and training time.
3. **Feature engineering** is the process of creating new features by transforming (e.g., taking the natural logarithm), decomposing, or combining multiple features. A related term is **feature extraction**, whereby a feature is created from the data set (e.g., creating a value for age using date-of-birth data).

Model performance depends heavily on feature selection and engineering, and it is common for the analyst to recursively go back to this step and apply tweaks until model performance is acceptable.

Data Exploration for Structured Data

With **EDA**, structured data is organized in rows (observations) and columns (features). EDA can be performed for a single feature (one dimension) or multiple features (multidimension). When the number of features is large, dimension reduction models such as **principal component analysis (PCA)** can facilitate data exploration.

- For a single feature, summary statistics include the mean, standard deviation, skewness, and kurtosis. EDA visualizations include box plots, histograms, density plots, and bar charts. Histograms capture the frequency of observations in a series of equal-width bins. Density plots are smoothed histograms for continuous data overlaid on top of histograms. Bar charts show frequency distributions of categorical variables (e.g., proportion of the population in each of the five geographical zones of the country). Box plots are used for continuous variables and highlight the median, quartiles, and outliers of a normally distributed feature.
- For multiple features, the summary statistic can be a correlation matrix. Data can be visually graphed using a scatterplot, box plots, stacked bar or a line graph. Multiple box plots can be plotted on the same line with each plot representing a feature. Parametric

statistical tests include ANOVA tables, correlation tables, and t -tests. Nonparametric statistical tests include the Spearman rank-order correlation and the chi-square test.

With **feature selection**, we try to select only the features that contribute to the out-of-sample predictive power of the model. A parsimonious model (i.e., a model with fewer features) reduces feature-induced noise and improves the model's prediction accuracy. Feature selection requires a good understanding of the business environment and the interrelationships among the features identified in the EDA. For structured data, feature selection is an iterative, methodical process. Features can be assigned an importance score using statistical methods and then ranked and selected based on that score. Dimension reduction algorithms may be employed to reduce the number of features needed so as to reduce processing time during model training.

Feature Engineering (FE) involves optimizing and improving the selected features. Model training results depend on how the features are presented to the algorithm. Feature engineering involves either decomposing a feature into multiple features or converting an existing feature into a new feature. **One-hot encoding (OHE)** is a process used to convert a categorical feature into a binary (dummy) variable suitable for machine processing. Feature engineering seeks to make model training faster and easier.

LOS 4.e: Describe methods for extracting, selecting and engineering features from textual data.

Data Exploration for Unstructured Data

Unstructured text can be tokenized, and summary statistics such as **term frequency** (number of times the word appears in the text) and **co-occurrence** (where two or more words appear together) can be analyzed. A **word cloud** is a visual representation of all the words in a BOW, such that words with higher frequency have a larger font size. This allows the analyst to determine which words are contextually more important. Figure 4.1 shows an example of a word cloud.

- **N-grams.** These are multiword patterns, and if they are useful, the order is preserved. For example, the words *expansionary monetary policy* may be best kept as a sequence rather than broken into three different tokens, and therefore would be replaced by a single token, *expansionary_monetary_policy*.
- **Name entity recognition (NER).** NER algorithms search for token values, in the context it was used, against their internal library and assign a NER tag to the token. For example, Microsoft would be assigned a NER tag of *ORG* and Europe would be assigned a NER tag of *Place*. NER object class assignment is meant to make the selected features more discriminatory.
- **Parts of speech (POS).** This uses language structure dictionaries to contextually assign tags (POS) to text. For example, Microsoft would be assigned a POS tag of *NNP* (indicating a proper noun), and the year 1969 would be assigned a POS tag of *CD* (indicating a cardinal number).



MODULE QUIZ 4.2

1. The process used to convert a categorical feature into a binary (dummy) variable is *best* described as:
 - A. one-hot encoding (OHE).
 - B. parts of speech (POS).
 - C. name entity recognition (NER).
2. To make a bag-of-words (BOW) concise, the *most appropriate* procedure would be to:
 - A. eliminate high- and low-frequency words.
 - B. use a word cloud.
 - C. use N-grams.
3. Mutual information (MI) of tokens that appear in one or few classes is *most likely* to be:
 - A. close to 0.
 - B. close to 1.
 - C. close to 100.

MODULE 4.3: MODEL TRAINING AND EVALUATION



Video covering this content is available online.

LOS 4.f: Describe objectives, steps, and techniques in model training.

Before model training, it is important to define the objective(s) of data analysis, identify useful data points, and conceptualize the model. Model conceptualization is the iterative planning phase that lays out the process to be followed. This process gets tweaked until the desired results are achieved. It is important that ML engineers work with domain experts so as to identify data characteristics and relationships (e.g., the relation between inflation and exchange rates).

Once the unstructured data has been processed and codified in a structured form such as a data matrix, model training is similar to that of structured data. ML seeks to identify patterns in the data set via a set of rules. Model fitting describes how well the model generalizes to new data (i.e., how the model performs out of sample).

Model fitting errors can be caused by:

- *Size of the training sample.* Small data sets do not provide adequate training and can lead to an underfit model that does not recognize important patterns.
- *Number of features.* Fewer features can also lead to an underfitting problem; the small number of features may not carry enough information to identify patterns in the training sample. On the other hand, data sets with a large number of features can lead to overfitting due to fewer degrees of freedom. Overfit models do not generalize well in the validation sample. The feature selection step discussed earlier is important in mitigating the overfitting and underfitting problems. FE, when properly done, tends to reduce the underfitting problem.



PROFESSOR'S NOTE

Model fitting is discussed in detail in the topic review on machine learning.

The three tasks of model training are as follows:

1. **Method selection** is the art and science of choosing the appropriate ML method (i.e., algorithm) given the objectives and data characteristics. Method selection is based on the following factors:
 - *Supervised or unsupervised learning.* Supervised learning is used when the training data contains the **ground truth** or the known outcome (i.e., the target variable). In such cases, available methods include regression, ensemble trees, **support vector machines (SVMs)**, and **neural networks (NNs)**. Unsupervised learning occurs when there is no target variable. Unsupervised learning methods include clustering, dimension reduction, and anomaly detection.
 - *Type of data.* For numerical data (e.g., predicting earnings) we may use classification and regression tree (CART) methods. For text data, we can use **generalized linear models (GLMs)** and SVMs. For image data, neural networks and deep learning methods can be employed.
 - *Size of data.* Large data sets with many observations and features can be handled with SVMs. Neural networks work better with a large number of observations, but few features.



PROFESSOR'S NOTE

These methods and their applications are discussed in detail in the topic review on machine learning.

Once a method is selected, the researcher has to specify appropriate hyperparameters (e.g., the number of hidden layers in a neural network). For mixed data sets (containing numerical and textual data), multiple methods are often used. Sometimes, the output of one method (e.g., classification of financial news text for a company as positive or negative) may be used as an input to another model. Sometimes, multiple models are employed, and a weighted average of the forecasts from those models is used.

For supervised learning, before model training begins, the data set is divided into three parts. The larger part ($\approx 60\%$) is used for model training. A second part ($\approx 20\%$) is used for validation and model tuning. The last part ($\approx 20\%$) is the test set, and is used to check the out-of-sample performance of the model. Due to the absence of labeled training data, no splitting of the data set is needed for unsupervised learning.

For a model to be able to discriminate well, it should be provided with a wide variety of training data. **Class imbalance** occurs when one class has a large number of observations relative to other classes. For example, in a model for predicting bond default, if the data set has a large number of high-grade bonds (i.e., those that would be less likely to default), then the model would be more likely to predict nondefault for a new observation. The training data set should have a variety of high- and low-grade bonds so as to have enough diversity to make correct predictions. One way to overcome class imbalance is to undersample the overrepresented class and oversample the underrepresented class.

2. **Performance evaluation** is the process of assessing model efficacy; various tools are used to quantify and critique model performance.
3. **Tuning** is the process of implementing changes to improve model performance.

These steps are recursively applied until a desired level of model performance is attained. We will next explore the performance evaluation and tuning steps in detail.

LOS 4.c: Evaluate the fit of a machine learning algorithm.

Techniques to Measure Model Performance

In order to validate a model, we must measure its training performance or goodness of fit. We will next consider a few methods to measure this performance. (These techniques are particularly suited to evaluating binary classification models.)

1. **Error analysis.** Errors in classification problems can be false positives (type I error) or false negatives (type II error). A **confusion matrix** shows the results of a classification problem, as in Figure 4.2.

Figure 4.2: Classification of Defaulters

	Actual: Default	Actual: No Default
Prediction: Default	True positive (TP)	False positive (FP, type I)
Prediction: No Default	False negative (FN, type II)	True negative (TN)

Metrics such as **precision** (the ratio of true positives to all predicted positives) and **recall** (the ratio of TPs to all actual positives) can be used. High precision is valued when the cost of a type I error is large, while high recall is valued when the cost of a type II error is large.

$$\text{precision (P)} = \text{TP} / (\text{TP} + \text{FP})$$

$$\text{recall (R)} = \text{TP} / (\text{TP} + \text{FN})$$

While FP and FN are both errors, they may not be equally important. The tradeoff between precision and recall is a business decision, and depends on the model application. For example, a lender may want to avoid lending to potential defaulters, and so will want to maximize recall. Together, model precision and recall determine model **accuracy**, which is the proportion of correct forecasts out of a total number of forecasts. The **F1 score** is the harmonic mean of precision and recall.

$$\text{accuracy} = (\text{TP} + \text{TN}) / (\text{TP} + \text{TN} + \text{FP} + \text{FN})$$

$$\text{F1 score} = (2 \times \text{P} \times \text{R}) / (\text{P} + \text{R})$$

2. **Receiver operating characteristic (ROC).** Also used for classification problems, the ROC is a curve that plots the tradeoff between FPs and TPs. The true positive rate (TPR) is the same as recall, and is plotted along the Y-axis. The false positive rate (FPR) is the ratio of FPs to all actual negatives, and is plotted along the X-axis.

$$\text{TPR} = \text{TP} / (\text{TP} + \text{FN})$$

$$\text{FPR} = \text{FP} / (\text{FP} + \text{TN})$$

Figure 4.3 shows the performance of the three models used to predict defaults. The area under the curve (AUC) is a value from 0 to 1. The closer the value of AUC is to 1, the higher the predictive accuracy of the model. An AUC value of 0.50 (indicated by a straight line, for model 1) indicates that the model makes a random guess. The higher the convexity of the ROC curve, the higher its AUC.

Figure 4.3: ROC Curves and AUC

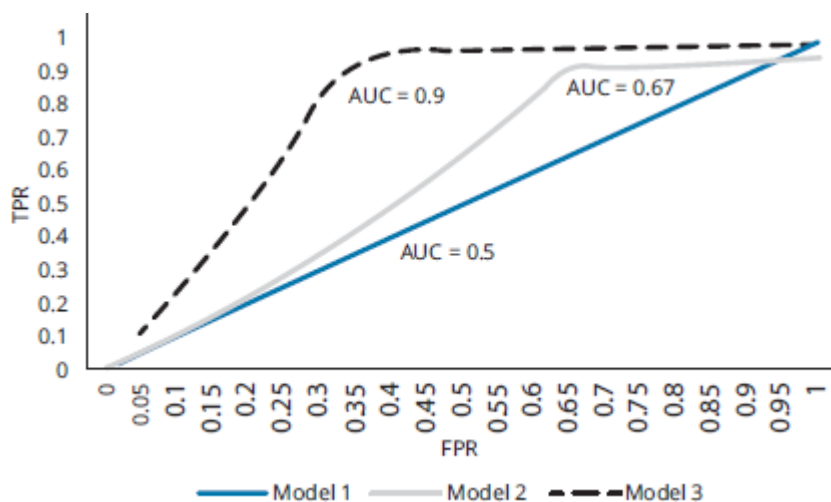

3. **Root mean squared error (RMSE).** This is useful for data predictions that are continuous, such as regression models. The RMSE is a single metric summarizing the prediction error in a sample.

$$\text{RMSE} = \sqrt{\frac{\sum_{i=1}^n (\text{predicted}_i - \text{actual}_i)^2}{n}}$$

EXAMPLE: Model evaluation

Dave Kwah is evaluating a model that predicts whether a company is likely to have a dividend cut next year. The model uses a binary classification: cut versus not cut. In the test sample consisting of 78 observations, the model correctly classified 18 companies that had a dividend cut, as well as 46 companies that did not have a dividend cut. The model failed to identify three companies that actually had a dividend cut.

1. Calculate the model's precision and recall.
2. Calculate the model's accuracy and F1 score.

3. Calculate the model's FPR.

Answer:

	Actual: Cut	Actual: Not Cut
Prediction: Cut	TP = 18	FP = 11
Prediction: Not Cut	FN = 3	TN = 46

1. Precision = $TP / (TP + FP) = 18 / (18 + 11) = 0.62$

Recall = $TP / (TP + FN) = 18 / (18 + 3) = 0.86$

2. Accuracy = $(TP + TN) / (TP + TN + FP + FN)$
 $= (18 + 46) / (18 + 3 + 11 + 46) = 64 / 78 = 0.82$

F1 score = $(2 \times P \times R) / (P + R) = (2 \times 0.62 \times 0.86) / (0.62 + 0.86)$
 $= 1.07 / 1.48 = 0.72$

3. FPR = $FP / (TN + FP) = 11 / (46 + 11) = 0.19$

Model Tuning

After model evaluation, the model needs to be revised until it reaches an acceptable performance level. **Bias error** is the prediction error in the training data resulting from underfit models. Bias errors occur from oversimplified models, which don't learn adequately from the training sample. **Variance error** is the prediction error in the validation sample resulting from overfitting models that do not generalize well. Overfitting is an issue with supervised ML that results when too many features are included in the training sample (i.e., the model is too complicated). It is necessary to find an optimum tradeoff between bias and variance errors, such that the model is neither underfitting nor overfitting.

A **fitting curve** is a plot of training error and cross-validation prediction error with varying model complexity (more complex = more features). An example of a fitting curve is shown in Figure 4.4.

Figure 4.4: Fitting Curve

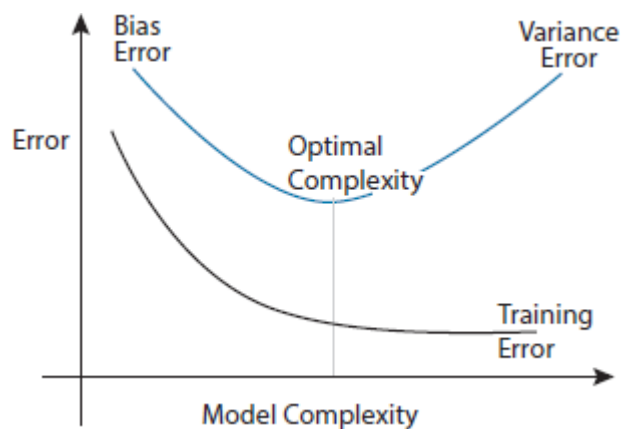

As a model's complexity increases, it starts overfitting the training sample, and training error (i.e., bias error) declines. However, this decrease in bias error comes at the cost of increasing variance error. Regularization seeks to reduce model complexity by imposing a penalty on features that don't meaningfully contribute to the predictive power of the model. Optimal model complexity balances the tradeoff between bias and variance error.

Parameters are estimated by the model (e.g., slope coefficients in a regression model) using an optimization technique on the training sample. **Hyperparameters** (e.g., the number of hidden layers in a neural network, or the p -threshold in logistic regression) are specified by ML engineers, and are independent of the training sample.

Tuning involves altering the hyperparameters until a desirable level of model performance is achieved. For each specification of hyperparameter(s), a confusion matrix is prepared based on the classification results, and accuracy and F1 scores are compiled. Rather than using a trial-and-error approach, especially if there are multiple hyperparameters in the model, one can use a **grid search**. A grid search is an automated process of selecting the best combination of hyperparameters.

Ceiling analysis is an evaluation and tuning of each of the components in the entire model-building pipeline. It identifies the weak link in the process, which can be tuned to improve the performance of the model.



MODULE QUIZ 4.3

1. When the training data contains the ground truth, the *most appropriate* learning method is:
 - A. supervised learning.
 - B. unsupervised learning.
 - C. machine learning.

Use the following information to answer Questions 2 through 6.

While analyzing health care stocks, Ben Stokes devises a model to classify the stocks as those that will report earnings above consensus forecasts versus those that won't. Stokes prepares the following confusion matrix using the results of his model.

Confusion Matrix for Earnings Outperformance

	Actual: Beat Forecast	Actual: Not Beat
Prediction: Beat Forecast	12	4
Prediction: Not Beat	2	7

2. The model's accuracy score is *closest* to:
 - A. 0.44.
 - B. 0.76.
 - C. 0.89.
3. The model's recall is *closest* to:
 - A. 0.67.
 - B. 0.72.
 - C. 0.86.
4. The model's precision is *closest* to:
 - A. 0.64.
 - B. 0.72.
 - C. 0.75.
5. The model's F1 score is *closest* to:
 - A. 0.80.
 - B. 0.89.
 - C. 0.94.
6. To reduce type I error, Stokes should *most* appropriately increase the model's:

- A. precision.
- B. recall.
- C. accuracy.

KEY CONCEPTS

LOS 4.a

The steps involved in a data analysis project include (1) conceptualization of the modeling task, (2) data collection, (3) data preparation and wrangling, (4) data exploration, and (5) model training.

LOS 4.b

Data cleansing deals with missing, invalid, inaccurate, and non-uniform values as well as with duplicate observations. Data wrangling or preprocessing includes data transformation and scaling. Data transformation types include extraction, aggregation, filtration, selection, and conversion of data. Scaling is the conversion of data to a common unit of measurement. Common scaling techniques include normalization and standardization. Normalization scales variables between the values of 0 and 1, while standardization centers the variables at a mean of 0 and a standard deviation of 1. Unlike normalization, standardization is not sensitive to outliers, but it assumes that the variable distribution is normal.

LOS 4.c

Model performance can be evaluated by using error analysis. For a classification problem, a confusion matrix is prepared, and evaluation metrics such as precision, recall, accuracy score, and F1 score are calculated.

$$\text{precision (P)} = \text{true positives} / (\text{true positives} + \text{false positives})$$

$$\text{recall (R)} = \text{true positives} / (\text{true positives} + \text{false negatives})$$

$$\text{accuracy} = (\text{true positives} + \text{true negatives}) / (\text{all positives and negatives})$$

$$\text{F1 score} = (2 \times \text{P} \times \text{R}) / (\text{P} + \text{R})$$

The receiver operating characteristic (ROC) plots a curve showing the tradeoff between false positives and true positives.

Root mean squared error (RMSE) is used when the target variable is continuous.

$$\text{RMSE} = \sqrt{\frac{\sum_{i=1}^n (\text{predicted}_i - \text{actual}_i)^2}{n}}$$

Model tuning involves balancing bias error versus variance error, and selecting the optimal combination of hyperparameters.

LOS 4.d

Data exploration involves exploratory data analysis (EDA), feature selection, and feature engineering (FE). EDA looks at summary statistics describing the data and any patterns or relationships that can be observed. Feature selection involves choosing only those features that meaningfully contribute to the model's predictive power. FE optimizes the selected features.

LOS 4.e

Summary statistics for textual data includes term frequency and co-occurrence. A word cloud is a visual representation of all the words in a BOW, such that words with higher frequency have a larger font size. This allows the analyst to determine which words are contextually more important. Feature selection can use tools such as document frequency, the chi-square test, and mutual information (MI). FE for text data includes identification of numbers, usage of N-grams, name entity recognition (NER), or parts of speech (POS) tokenization.

LOS 4.f

Before model training, the model is conceptualized where ML engineers work with domain experts to identify data characteristics and relationships. ML seeks to identify patterns in the training data, such that the model is able to generalize to out-of-sample data. Model fitting errors can be caused by using a small training sample or by using an inappropriate number of features. Too few features may underfit the data, while too many features can lead to the problem of overfitting.

Model training involves model selection, model evaluation, and tuning.

LOS 4.g

Text processing involves removing HTML tags, punctuations, numbers, and white spaces. Text is then normalized by lowercasing of words, removal of stop words, stemming, and lemmatization. Text wrangling involves tokenization of text. N-grams is a technique that defines a token as a sequence of words, and is applied when the sequence is important. A bag-of-words (BOW) procedure then collects all the tokens in a document. A document term matrix organizes text as structured data: documents are represented by words, and tokens by columns. Cell values reflect the number of times a token appears in a document.

ANSWER KEY FOR MODULE QUIZZES

Module Quiz 4.1

1. **A** Structured formative analysis is not a term defined in the curriculum. The five steps of data analysis include conceptualization of modeling task; data collection; data preparation and wrangling; data exploration; and model training. (LOS 4.a)
2. **B** Common values are not *cleansed*. Missing, invalid, non-uniform, and inaccurate values are *cleaned*. (LOS 4.b)
3. **C** Normalization scales variable values between 0 and 1. (LOS 4.b)

Module Quiz 4.2

1. **A** OHE is a process used to convert a categorical feature into a binary (dummy) variable suitable for machine processing. POS and NER are mechanisms used to assign tags to tokens. (LOS 4.d)
2. **A** To make a BOW concise, usually high- and low-frequency words are eliminated. High-frequency words tend to be stop words or common vocabulary words. A word cloud

is a text data visualization tool. N-grams are used when the sequence of words is important. (LOS 4.e)

3. **B** MI is a numerical value indicating the contribution of a token to a class of text. Tokens appearing in all classes will have an MI value close to 0, while tokens in one or a few classes should have an MI value close to 1. (LOS 4.e)

Module Quiz 4.3

1. **A** Supervised learning is used when the training data contains ground truth (i.e., the known outcome, or target variable). Unsupervised learning is used when there is no known target variable. Machine learning (ML) includes a broad array of algorithms, including supervised and unsupervised ML. (LOS 4.f)

The following matrix answers Questions 2 through 6:

Confusion Matrix for Earnings Outperformance

	Actual: Beat Forecast	Actual: Not Beat
Prediction: Beat Forecast	TP = 12	FP = 4
Prediction: Not Beat	FN = 2	TN = 7

2. **B** Accuracy = $(TP + TN) / (TP + TN + FP + FN) = 19 / 25 = 0.76$.
(LOS 4.c)
3. **C** Recall (R) = $TP / (TP + FN) = 12 / 14 = 0.86$.
(LOS 4.c)
4. **C** Precision (P) = $TP / (TP + FP) = 12 / 16 = 0.75$.
(LOS 4.c)
5. **A** F1 score = $(2 \times P \times R) / (P + R) = (2 \times 0.75 \times 0.86) / (0.75 + 0.86) = 0.80$.
(LOS 4.c)
6. **A** High precision is valued when the cost of a type I error (i.e., FP) is large, while high recall is valued when the cost of a type II error (i.e., FN) is large. (LOS 4.c)

Topic Quiz: Quantitative Methods

You have now finished the Quantitative Methods topic section. Please log into your Schweser online dashboard and take the Topic Quiz on this section. The Topic Quiz provides immediate feedback on how effective your study has been for this material. Questions are more exam-like than typical Module Quiz or QBank questions; a score of less than 70% indicates that your study likely needs improvement. These tests are best taken timed; allow three minutes per question.

READING 5

CURRENCY EXCHANGE RATES: UNDERSTANDING EQUILIBRIUM VALUE

EXAM FOCUS

There's no fluff here; you need it all. Take it slow and get a good understanding of quotes, currency cross rates, triangular arbitrage, all parity conditions, and their interrelationships. Forecasting exchange rates has important applications for valuation (which is the focus of Level II). Accordingly, theories of exchange rate determination as well as factors influencing exchange rates are all important. Be prepared to identify warning signs of currency crises.

MODULE 5.1: FOREX QUOTES, SPREADS, AND TRIANGULAR ARBITRAGE



Video covering
this content is
available online.

LOS 5.a: Calculate and interpret the bid–offer spread on a spot or forward currency quotation and describe the factors that affect the bid–offer spread.



PROFESSOR'S NOTE

The “bid–offer” spread is also known as the “bid–ask” spread: the terms “ask” and “offer” mean the same thing. Accordingly, we will be using them interchangeably.

Exchange Rates

An **exchange rate** is simply the price of one currency in terms of another. For example, a quote of 1.4126 USD/EUR means that each euro costs \$1.4126. In this example, the euro is called the *base* currency and the USD the *price* currency. Hence, a quote is the price of one unit of the base currency in terms of the price currency.

A **spot exchange rate** is the currency exchange rate for immediate delivery, which for most currencies means the exchange of currencies takes place two days after the trade. A **forward exchange rate** is a currency exchange rate for an exchange to be done in the future. Forward rates are quoted for various future dates (e.g., 30 days, 60 days, 90 days, or one year). A forward contract is an agreement to exchange a specific amount of one currency for a specific amount of another currency on a future date specified in the forward agreement.

Dealer quotes often include both bid and offer (ask) rates. For example, the euro could be quoted as \$1.4124 – 1.4128. The bid price (\$1.4124) is the price at which the dealer will buy euros, and the offer price (\$1.4128) is the price at which the dealer will sell euros.

Foreign Exchange Spread

The difference between the offer and bid price is called the *spread*. Spreads are often stated as “pips.” When the spot quote has four decimal places, one pip is 1/10,000. In the previous example, the spread is \$0.0004 (4 pips) reflecting the dealer’s profit. Dealers manage their foreign currency inventories by transacting in the interbank market (think of this as a wholesale market for currency). Spreads are narrow in the interbank market.

The spread quoted by a dealer depends on:

- **The spread in an interbank market for the same currency pair.** Dealer spreads vary directly with spreads quoted in the interbank market.
- **The size of the transaction.** Larger, liquidity-demanding transactions generally get quoted a larger spread.
- **The relationship between the dealer and client.** Sometimes dealers will give favorable rates to preferred clients based on other ongoing business relationships.

The interbank spread on a currency pair depends on:

- **Currencies involved.** Similar to stocks, high-volume currency pairs (e.g., USD/EUR, USD/JPY, and USD/GBP) command lower spreads than do lower-volume currency pairs (e.g., AUD/CAD).
- **Time of day.** The time overlap during the trading day when both the New York and London currency markets are open is considered the most liquid time window; spreads are narrower during this period than at other times of the day.
- **Market volatility.** Spreads are directly related to the exchange rate volatility of the currencies involved. Higher volatility leads to higher spreads to compensate market makers for the increased risk of holding those currencies. Spreads change over time in response to volatility changes.

In addition to these factors, spreads in forward exchange rate quotes increase with maturity. The reasons for this are: longer maturity contracts tend to be less liquid, counterparty credit risk in forward contracts increases with maturity, and interest rate risk in forward contracts increases with maturity.

Warm-Up: Working with Foreign Exchange Quotes

Earlier, we stated that a dealer will sell a currency at the ask price and purchase it at the bid price. We need to be a bit more specific. For example, imagine that you are given a USD/AUD bid and ask quote of 1.0508-1.0510. Investors can buy AUD (i.e., the base currency) from the dealer at the ask price of USD 1.0510. Similarly, investors can sell AUD to the dealer at the bid price of USD 1.0508. Remember, investors always take a loss due to the spread. So the rule is *buy the base currency at ask, and sell the base currency at bid*.

For transactions in the price currency, we do the opposite. If we need to buy USD (i.e., the price currency) using AUD (i.e., selling the base currency), we now use the dealer *bid* quote. Similarly, to sell the price currency, we use the dealer *ask* quote. So the rule is *buy the price currency at bid, and sell the price currency at ask*.

Alternatively, it is useful to follow the *up-the-bid-and-multiply, down-the-ask-and-divide rule*. Again given a USD/AUD quote, if you want to convert USD into AUD (you are going down the quote—from USD on top to AUD on bottom), use the *ask* price for that quote. Conversely, if you want to convert AUD into USD, you are going up the quote (from bottom to top) and, hence, use the *bid* price.

EXAMPLE: Converting currencies using spot rates

A dealer is quoting the AUD/GBP spot rate as 1.5060 – 1.5067. How would we:

1. Compute the proceeds of converting 1 million GBP.
2. Compute the proceeds of converting 1 million AUD.

Answer:

1. To convert 1 million GBP into AUD, we go “up the quote” (i.e., from GBP in the denominator to AUD in the numerator). Hence, we would use the *bid* price of 1.5060 and multiply.

$$1 \text{ million GBP} \times 1.5060 = 1,506,000 \text{ AUD}$$

2. To convert 1 million AUD into GBP, we go “down the quote” (i.e., from AUD in the numerator to GBP in the denominator). Hence, we would use the *ask* price of 1.5067 and divide.

$$1 \text{ million AUD} / 1.5067 = 663,702.13 \text{ GBP}$$

LOS 5.b: Identify a triangular arbitrage opportunity and calculate its profit, given the bid–offer quotations for three currencies.

Cross Rate

The **cross rate** is the exchange rate between two currencies implied by their exchange rates with a common third currency. It is necessary to use cross rates when there is no active foreign exchange (FX) market in the currency pair being considered. The cross rate must be computed from the exchange rates between each of these two currencies and a major third currency, usually the USD or EUR.

Suppose we have the following quotes:

USD/AUD = 0.60 and MXN/USD = 10.70. What is the cross rate between Australian dollars and pesos (MXN/AUD)?

$$\frac{\text{MXN}}{\text{AUD}} = \frac{\text{USD}}{\text{AUD}} \times \frac{\text{MXN}}{\text{USD}} = 0.60 \times 10.70 = 6.42$$

So our MXN/AUD cross rate is 6.42 pesos per Australian dollar. The key to calculating cross rates is to make sure the common currency cancels out.

Cross Rates with Bid–Ask Spreads

Bid–ask spreads complicate the calculation of cross rates considerably. Suppose we are given three currencies A, B, and C; we can have three pairs of currencies (i.e., A/B, A/C, and B/C).

Rules:

$$\left(\frac{A}{C}\right)_{\text{bid}} = \left(\frac{A}{B}\right)_{\text{bid}} \times \left(\frac{B}{C}\right)_{\text{bid}}$$

$$\left(\frac{A}{C}\right)_{\text{offer}} = \left(\frac{A}{B}\right)_{\text{offer}} \times \left(\frac{B}{C}\right)_{\text{offer}}$$

To compute the cross rate for A/C, given A/B and B/C, we can follow these rules to obtain the bid and offer prices. If we are instead given A/B and C/B rates, we will have to make adjustments to obtain the B/C bid and offer rates from the C/B bid and offer rates, because $A/B \times C/B \neq A/C$. The process is as follows:

$$\left(\frac{B}{C}\right)_{\text{bid}} = \frac{1}{\left(\frac{C}{B}\right)_{\text{offer}}}$$

$$\left(\frac{B}{C}\right)_{\text{offer}} = \frac{1}{\left(\frac{C}{B}\right)_{\text{bid}}}$$

Triangular Arbitrage

Real-world currency dealers will maintain bid/ask quotes that ensure a profit to the dealer, regardless of which currencies customers choose to trade. If this was not the case, customers could earn profits through the process of triangular arbitrage. In **triangular arbitrage**, we begin with three pairs of currencies, each with bid and ask quotes, and construct a triangle where each node in the triangle represents one currency. To check for arbitrage opportunities, we go around the triangle clockwise (and later, counterclockwise) until we reach our starting point. As before, we follow the up-the-bid-and-multiply, down-the-ask-and-divide rule.

The following example will illustrate triangular arbitrage.

EXAMPLE: Triangular arbitrage

The following quotes are available from the interbank market:

Quotes:

USD/AUD 0.6000 – 0.6015

USD/MXN 0.0933 – 0.0935

1. Compute the implied MXN/AUD cross rate.
2. If your dealer quotes MXN/AUD = 6.3000 – 6.3025, is an arbitrage profit possible? If so, compute the arbitrage profit in USD if you start with USD 1 million.

Answer:

1. To compute implied cross rates, we need:

$$\left(\frac{\text{MXN}}{\text{AUD}}\right)_{\text{bid}} = \left(\frac{\text{USD}}{\text{AUD}}\right)_{\text{bid}} \times \left(\frac{\text{MXN}}{\text{USD}}\right)_{\text{bid}}$$

Since we are given USD/MXN quotes instead of MXN/USD quotes, we first invert these quotes:

$$\left(\frac{\text{MXN}}{\text{USD}}\right)_{\text{bid}} = \frac{1}{\left(\frac{\text{USD}}{\text{MXN}}\right)_{\text{offer}}} = \left(\frac{1}{0.0935}\right) = 10.70 \text{ MXN/USD}$$

and

$$\left(\frac{\text{MXN}}{\text{USD}}\right)_{\text{offer}} = \frac{1}{\left(\frac{\text{USD}}{\text{MXN}}\right)_{\text{bid}}} = \left(\frac{1}{0.0933}\right) = 10.72 \text{ MXN/USD}$$

Now, the implied cross rates:

$$\left(\frac{\text{MXN}}{\text{AUD}}\right)_{\text{bid}} = \left(\frac{\text{USD}}{\text{AUD}}\right)_{\text{bid}} \times \left(\frac{\text{MXN}}{\text{USD}}\right)_{\text{bid}} = 0.60 \times 10.70 = 6.42$$

$$\left(\frac{\text{MXN}}{\text{AUD}}\right)_{\text{offer}} = \left(\frac{\text{USD}}{\text{AUD}}\right)_{\text{offer}} \times \left(\frac{\text{MXN}}{\text{USD}}\right)_{\text{offer}} = 0.6015 \times 10.72 = 6.4481$$

2. Since the dealer quote of MXN/AUD = 6.3000 – 6.3025 falls outside of these cross rates, arbitrage profit may be possible (we have to check this). Remember to use the dealer quotes in the triangle and not the cross rates we computed.

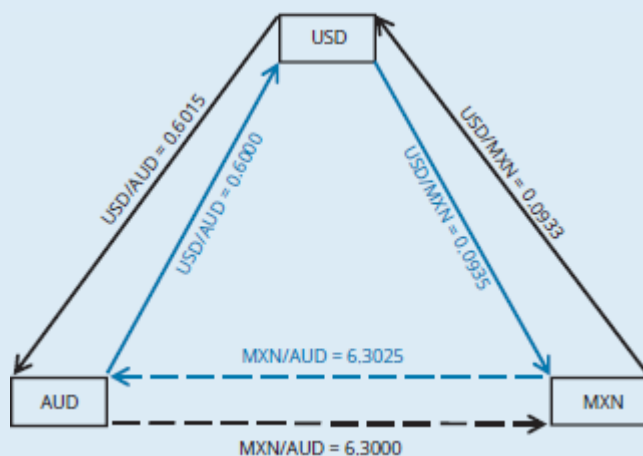

To label the arrows in this triangle, we follow the “up the bid, down the offer” rule. To convert from USD to MXN, (“down” with respect to the USD/MXN quote), we use the offer rate of 0.0935.

Going clockwise and starting with USD 1 million:

1. Convert USD 1 million into MXN @ 0.0935 USD/MXN. Note that the quote is USD/MXN and hence we are going down, and thus need to use the ask. Also remember: down, divide. We get 1 million/0.0935 = 10,695,187 MXN.
2. Next, we convert 10,695,187 MXN into AUD @ 6.3025 MXN/AUD to get 1,696,975 AUD.

3. Finally, we convert AUD 1,696,975 into USD @ 0.6000 USD/AUD. Here the quote is USD/AUD and we are converting from AUD to USD, so we are going “up the quote” and need to multiply by the bid. (Remember: up, multiply.) We get $1,696,975 \times 0.60 = 1,018,185$ USD – a profit of 18,185 USD.

We can also check for arbitrage in the counter-clockwise direction (even though we can never earn an arbitrage profit in both directions):

1. Convert USD 1 million into AUD using 0.6015. Again, the quote is USD/AUD and we are going down, so use the ask price and divide. We get $1 \text{ million} / 0.6015 = 1,662,510$ AUD.
2. Next, we convert 1,662,510 AUD into MXN using 6.3000 to get 10,473,814 MXN.
3. Finally, we convert MXN 10,473,814 into USD at 0.0933 to get 977,207 USD – a loss of 22,793 USD.

LOS 5.c: Explain spot and forward rates and calculate the forward premium/discount for a given currency.

A currency is quoted at a **forward premium** relative to a second currency if the forward price (in units of the second currency) is *greater* than the spot price. A currency is quoted at a **forward discount** relative to a second currency if the forward price (in units of the second currency) is *less* than the spot price. The premium or discount is for the base currency (i.e., the currency at the bottom of the quote). For example, if the spot price is 1.20\$/€ and the forward price is 1.25\$/€, we say that the euro is trading at a forward premium.

$$\text{forward premium (discount)} = F - S_0$$

Given a quote of A/B, if this equation results in a positive value, we say that currency B (i.e., the base currency) is trading at a *premium* in the forward market.

In the FX markets, forward quotes are often presented as a premium or discount over spot rates. The following example illustrates this convention.

EXAMPLE: Spot and forward quotes

Given the following quotes for AUD/CAD, compute the bid and offer rates for a 30-day forward contract.

<u>Maturity</u>	<u>Rate</u>
Spot	1.0511/1.0519
30-day	+3.9/+4.1
90-day	+15.6/+16.8
180-day	+46.9/+52.3

Answer:

Since the forward quotes presented are all positive, the CAD (i.e., the base currency) is trading at a forward *premium*.

30-day bid = $1.0511 + 3.9/10,000 = 1.05149$

30-day offer = $1.0519 + 4.1/10,000 = 1.05231$

The 30-day all-in forward quote for AUD/CAD is 1.05149/1.05231.



PROFESSOR'S NOTE

For an investor wishing to convert AUD into CAD in the forward market, the relevant quote would be the ask rate (remember the “down-the-ask” rule) of 1.05231. This is also known as the all-in (i.e., after adding (subtracting) the forward premium (discount) rate for the investor in question.



MODULE QUIZ 5.1

1. All of the following factors are likely to contribute to an increase in USD/EUR dealer spread except:

- A. increase in the volatility of EUR/USD spot rate.
- B. increase in the EUR/USD spread in the interbank market.
- C. smaller order size.

2. The bid–ask quotes for the USD, GBP, and EUR are:

EUR/USD: 0.7000 – 0.7010

USD/GBP: 1.7000 – 1.7010

EUR/GBP: 1.2000 – 1.2010

The potential arbitrage profit from a triangular arbitrage based on an initial position of 1 million USD is *closest* to:

- A. USD0.
- B. USD7,212.
- C. USD6,372.

MODULE 5.2: MARK-TO-MARKET VALUE, AND PARITY CONDITIONS



Video covering this content is available online.

LOS 5.d: Calculate the mark-to-market value of a forward contract.

If the forward contract price is consistent with covered interest rate parity (discussed later), the value of the contract at initiation is zero to both parties. After initiation, the value of the forward contract will change as forward quotes for the currency pair change in the market.

Mark-to-Market Value

The value of a forward currency contract prior to expiration is also known as the *mark-to-market value*. To compute the value of a forward contract prior to expiration, we take the difference between the forward price we locked-in and the current forward price, multiply

that by the size of the contract, and then discount for the time period remaining until the contract settlement date.

$$V_t = \frac{(FP_t - FP)(\text{contract size})}{\left[1 + R\left(\frac{\text{days}}{360}\right)\right]}$$

where:

V_t = value of the forward contract at time t (to the party buying the base currency), ($t < T$) denominated in price currency

FP_t = forward price (to sell base currency) at time t in the market for a new contract maturing at time T

FP = forward price specified in the contract at inception (to buy the base currency)

days = number of days remaining to maturity of the forward contract ($T - t$)

R = interest rate of price currency



PROFESSOR'S NOTE

The interest rate references used throughout this reading are the rates on bank deposits using the appropriate market reference rate (MRR), and based on the days/360 convention. MRR is the generic label used in the CFA curriculum to represent various LIBOR successors globally.

EXAMPLE: Valuing a forward contract prior to maturity

Yew Mun Yip has entered into a 90-day forward contract long CAD 1 million against AUD at a forward rate of 1.05358 AUD/CAD. Thirty days after initiation, the following AUD/CAD quotes are available:

Maturity	FX Rate
Spot	1.0612/1.0614
30-day	+4.9/+5.2
60-day	+8.6/+9.0
90-day	+14.6/+16.8
180-day	+42.3/+48.3

The following information is available (at $t = 30$) for AUD interest rates:

30-day rate: 1.12%

60-day rate: 1.16%

90-day rate: 1.20%

What is the mark-to-market value in AUD of Yip's forward contract?

Answer:

Yip's contract calls for long CAD (i.e., converting AUD to CAD). To value the contract, we would look to unwind the position. To unwind the position, Yip can take an offsetting position in a new forward contract with the same maturity. Hence, Yip would be selling CAD in exchange for AUD and, hence, going up the bid (i.e., use the bid price). Note that after 30 days, 60 more days remain in the original contract.

The forward bid price for a new contract expiring in $T - t = 60$ days is $1.0612 + 8.6/10,000 = 1.06206$.

The interest rate to use for discounting the value is also the 60-day AUD interest rate of 1.16%:

$$V_t = \frac{(FP_t - FP)(\text{contract size})}{\left[1 + R\left(\frac{\text{days}}{360}\right)\right]} = \frac{(1.06206 - 1.05358)(1,000,000)}{\left[1 + 0.0116\left(\frac{60}{360}\right)\right]} = 8,463.64$$

Thirty days into the forward contract, Yip's position has gained (positive value) AUD 8,463.64. This is because Yip's position is long CAD, which has appreciated relative to AUD since inception of the contract. Yip can close out the contract on that day and receive AUD 8,463.64.

Note: Be sure to use the AUD (price currency) interest rate.

LOS 5.e: Explain international parity conditions (covered and uncovered interest rate parity, forward rate parity, purchasing power parity, and the international Fisher effect).

Covered Interest Rate Parity

The word *covered* in the context of covered interest parity means bound by arbitrage.

Covered interest rate parity holds when any forward premium or discount exactly offsets differences in interest rates, so that an investor would earn the same return investing in either currency. If euro interest rates are higher than dollar interest rates, the forward discount on the euro relative to the dollar will just offset the higher euro interest rate.

Formally, covered interest rate parity requires that (given A/B quote structure):

$$F = \frac{\left[1 + R_A\left(\frac{\text{days}}{360}\right)\right]}{\left[1 + R_B\left(\frac{\text{days}}{360}\right)\right]} S_0$$

where:

F = forward rate (quoted as A/B)

S_0 = spot rate (quoted as A/B)

days = number of days in the underlying forward contract

R_A = interest rate for Currency A

R_B = interest rate for Currency B



PROFESSOR'S NOTE

For all parity relations, follow the numerator-denominator rule. If you are given a USD/EUR quote, the USD interest rate should be in the numerator and the EUR interest rate in the denominator of the parity equation.

Recall that:

$$\text{forward premium (discount)} = F - S_0 = \left[\frac{1 + R_A \left(\frac{\text{days}}{360} \right)}{1 + R_B \left(\frac{\text{days}}{360} \right)} - 1 \right] S_0$$

or

$$\text{forward premium (discount)} = F - S_0 = S_0 \left[\frac{\left(\frac{\text{days}}{360} \right)}{1 + R_B \left(\frac{\text{days}}{360} \right)} \right] (R_A - R_B)$$

EXAMPLE: Covered interest arbitrage

The U.S. dollar MRR is 8%, and the euro MRR is 6%. The spot exchange rate is \$1.30 per euro (USD/EUR), and the 1-year forward rate is \$1.35 per euro. Determine whether a profitable arbitrage opportunity exists, and illustrate such an arbitrage if it does.

Answer:

First, we note that the forward value of the euro is too high. Interest rate parity would require a forward rate of:

$$\$1.30(1.08 / 1.06) = \$1.3245$$

Because the market forward rate of \$1.35 is higher than that implied by interest rate parity, we should sell euros in the forward market and do the opposite (i.e., buy euros) in the spot market. The steps in the covered interest arbitrage are as follows.

Initially:

Step 1: Borrow \$1,000 at 8%.

Step 2: Purchase $1,000 / 1.30 = 769.23$ euros in the spot market.

Step 3: Invest the euros at 6%.

Step 4: Enter into a forward contract to sell the expected proceeds at the end of one year (i.e., $769.23 \times 1.06 = 815.38$ euros), at \$1.35 each.

After one year:

Step 1: Sell the 815.38 euros under the terms of the forward contract at \$1.35 to get \$1,100.76.

Step 2: Repay the \$1,000 8% loan, which requires \$1,080.

Step 3: Keep the difference of \$20.76 as an arbitrage profit.

Uncovered Interest Rate Parity

With covered interest rate parity, arbitrage will force the forward contract exchange rate to a level consistent with the difference between the two country's nominal interest rates. If forward currency contracts are not available, or if capital flows are restricted so as to prevent arbitrage, the relationship need not hold. **Uncovered interest rate parity** refers to such a situation; uncovered in this context means not bound by arbitrage.

Consider Country A where the interest rate is 4%, and Country B where the interest rate is 9%. Under uncovered interest rate parity, currency B is expected to depreciate by 5%

annually relative to currency A, so that an investor should be indifferent between investing in Country A or B.

Given a quote structure of A/B, the base currency (i.e., currency B) is expected to appreciate by approximately $R_A - R_B$. (When $R_A - R_B$ is negative, currency B is expected to depreciate). Mathematically:

$$E(\% \Delta S)_{(A/B)} = R_A - R_B$$

The following example illustrates the use of uncovered interest rate parity to *forecast* future spot exchange rates using market interest rates.

EXAMPLE: Forecasting spot rates with uncovered interest rate parity

Suppose the spot exchange rate quote is ZAR/EUR = 8.385. The 1-year nominal rate in the eurozone is 10% and the 1-year nominal rate in South Africa is 8%. Calculate the expected percentage change in the exchange rate over the coming year using uncovered interest rate parity.

Answer:

The rand interest rate is less than the euro interest rate, so uncovered interest rate parity predicts that the value of the rand will rise (it will take fewer rand to buy one euro) because of higher interest rates in the eurozone. The euro (the base currency) is expected to “appreciate” by approximately $R_{\text{ZAR}} - R_{\text{EUR}} = 8\% - 10\% = -2\%$. (Note the *negative* 2% value.) Thus the euro is expected to *depreciate* by 2% relative to the rand, leading to a change in exchange rate from 8.385 ZAR/EUR to 8.217 ZAR/EUR over the coming year.

Comparing covered and uncovered interest parity, we see that covered interest rate parity derives the *no-arbitrage forward rate*, while uncovered interest rate parity derives the *expected future spot rate* (which is not market traded). Covered interest parity is assumed by arbitrage, but this is not the case for uncovered interest rate parity.

Under uncovered interest rate parity, if the foreign interest rate is higher by 2%, the foreign currency is expected to depreciate by 2%, so the investor should be indifferent between investing in the foreign currency or in their own domestic currency. An investor that chooses to invest in the foreign currency without any additional return (the interest rate differential is offset by currency value changes) is not demanding a risk premium for the foreign currency risk. Hence, uncovered interest rate parity assumes that the investor is *risk-neutral*.

If the forward rate is equal to the expected future spot rate, we say that the forward rate is an **unbiased predictor** of the future spot rate. In such an instance, $F = E(S_1)$; this is called **forward rate parity**. In this special case, if covered interest parity holds (and it will; by arbitrage) uncovered interest parity would also hold (and vice versa). Stated differently, if uncovered interest rate parity holds, forward rate parity also holds (i.e., the forward rate is an unbiased predictor of the future spot rate).

There is no reason that uncovered interest rate parity must hold in the short run, and indeed it typically does not. There is evidence that it does generally hold in the long run, so longer-term expected future spot rates based on uncovered interest rate parity are often used as forecasts of future exchange rates.

(Domestic) Fisher Relation

Professor Irving Fisher originated the idea that the nominal rate of return is (approximately) the sum of the real rate and the expected rate of inflation.

We can write this relation (known as the Fisher relation) as:

$$R_{\text{nominal}} = R_{\text{real}} + E(\text{inflation})$$

International Fisher Relation

Under **real interest rate parity**, real interest rates are assumed to converge across different markets. Taking the Fisher relation and real interest rate parity together gives us the **international Fisher effect**:

$$R_{\text{nominal A}} - R_{\text{nominal B}} = E(\text{inflation}_A) - E(\text{inflation}_B)$$

This tells us that the difference between two countries' nominal interest rates should be equal to the difference between their expected inflation rates.

The argument for the equality of real interest rates across countries is based on the idea that with free capital flows, funds will move to the country with a higher real rate until real rates are equalized.

EXAMPLE: Calculating the real interest rate

Suppose the nominal South African interest rate is 9.0% and the expected inflation rate is 3.5%. Calculate the real interest rate.

Answer:

$$0.090 = \text{real } r_{\text{ZAR}} + 0.035$$

$$\text{real } r_{\text{ZAR}} = 0.090 - 0.035 = 0.055, \text{ or } 5.5\%$$

If we move to a 2-country scenario, we will now have two nominal interest rates and two expected inflation rates. If the real rates for both countries are assumed to be equal, they drop out of the equation, and we are left with the international Fisher relation, as shown in the following example.

EXAMPLE: Using the international Fisher relation

Suppose that the eurozone expected annual inflation rate is 9.0%, and that the expected South African inflation rate is 13.0%. The nominal interest rate is 10.09% in the eurozone. Use the international Fisher relation to estimate the nominal interest rate in South Africa.

Answer:

real rate ZAR = real rate EUR \approx (nominal interest rate in the eurozone) – (eurozone expected annual inflation rate) = 10.09% – 9% = 1.09%

$R_{\text{ZAR}} = (\text{expected South African inflation rate}) + (\text{real ZAR interest rate})$

= 13% + 1.09% = 14.09%

Purchasing Power Parity

The law of one price states that identical goods should have the same price in all locations. For instance, a pair of designer jeans should cost the same in Paris as they do in New York, after adjusting for the exchange rate. The potential for arbitrage is the basis for the law of one price: if designer jeans cost less in New York than they do in Paris, an enterprising individual will buy designer jeans in New York and sell them in Paris, until this action causes the price differential to disappear. Note, however, that the law of one price does not hold in practice, due to the effects of frictions such as tariffs and transportation costs.

Instead of focusing on individual products, **absolute purchasing power parity** (absolute PPP) compares the average price of a representative basket of consumption goods between countries using an index such as The United States **Consumer Price Index (CPI)**. Absolute PPP requires only that the law of one price be correct *on average*, that is, for like baskets of goods in each country.

$$S(A/B) = \text{CPI}(A) / \text{CPI}(B)$$

In practice, even if the law of one price held for every good in two economies, absolute PPP might not hold because the weights (consumption patterns) of the various goods in the two economies may not be the same (e.g., people eat more potatoes in Russia and more rice in Japan).

Relative Purchasing Power Parity

Relative purchasing power parity (relative PPP) states that changes in exchange rates should exactly offset the price effects of any inflation differential between two countries. Simply put, if (over a 1-year period) Country A has a 6% inflation rate and Country B has a 4% inflation rate, then Country A's currency should *depreciate* by approximately 2% relative to Country B's currency over the period.

The equation for relative PPP is as follows:

$$\% \Delta S_{(A/B)} = \text{Inflation}_{(A)} - \text{Inflation}_{(B)}$$

where:

$$\% \Delta S_{(A/B)} = \text{change in spot price (A/B)}$$

Relative PPP is based on the idea that even if absolute PPP does not hold, there may still be a relationship between changes in the exchange rate and differences between the inflation rates of the two countries.

Ex-Ante Version of PPP

The ex-ante version of purchasing power parity is the same as relative purchasing power parity except that it uses *expected* inflation instead of actual inflation.

The following example illustrates the use of the ex-ante version of the PPP relation.

EXAMPLE: Calculating the exchange rate predicted by the ex-ante version of PPP

The current spot rate is USD/AUD = 1.00. You expect the annualized Australian inflation rate to be 5%, and the annualized U.S. inflation rate to be 2%. According to the ex-ante version of PPP, what is the expected change in the spot rate over the coming year?

Answer:

Since the AUD has the higher expected inflation rate, we expect that the AUD will depreciate relative to the USD. To keep the cost of goods and services the same across borders, countries with higher rates of inflation should see their currencies depreciate. The expected change in the spot rate over the coming year is $\text{inflation(USD)} - \text{inflation(AUD)} = 2\% - 5\% = -3\%$. This predicts a new USD/AUD exchange rate of approximately 0.97 USD/AUD.

Because there is no true arbitrage available to force relative PPP to hold, violations of relative PPP in the short run are common. However, because the evidence suggests that the relative form of PPP holds approximately in the long run, it remains a useful method for estimating the relationship between exchange rates and inflation rates.

LOS 5.f: Describe relations among the international parity conditions.

It is useful to establish how all the parity relations described earlier fit together. Figure 5.1 shows the interrelationships among parity conditions. Though these relationships are not all exact, together they provide an extremely useful framework for thinking about exchange rates.

Figure 5.1: The International Parity Relationships Combined

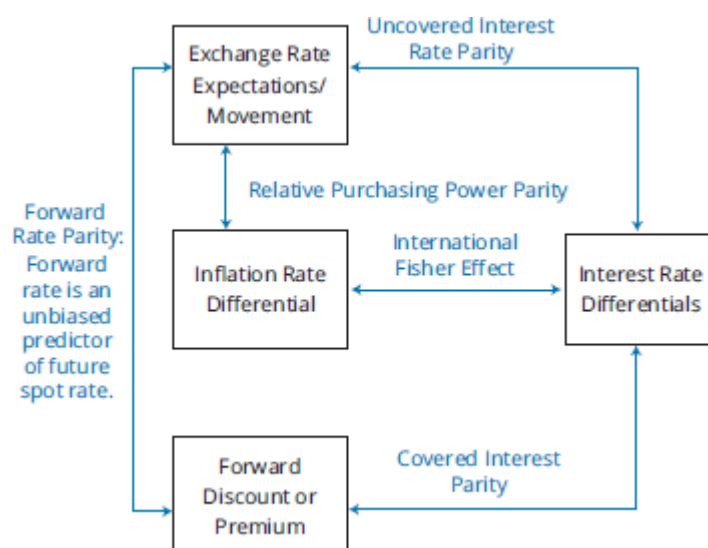

Several observations can be made from the relationships among the various parity conditions:

- Covered interest parity holds by arbitrage. If forward rate parity holds, uncovered interest rate parity also holds (and vice versa).
- Interest rate differentials should mirror inflation differentials. This holds true if the international Fisher relation holds. If that is true, we can also use inflation differentials to forecast future exchange rates—which is the premise of the ex-ante version of PPP.
- If the ex-ante version of relative PPP as well as the international Fisher relation both hold, uncovered interest rate parity will also hold.

LOS 5.g: Evaluate the use of the current spot rate, the forward rate, purchasing power parity, and uncovered interest parity to forecast future spot exchange rates.

LOS 5.h: Explain approaches to assessing the long-run fair value of an exchange rate.

We can use ex-ante PPP, uncovered interest rate parity, or forward rates to forecast future spot rates. As stated earlier, uncovered interest rate parity and PPP are not bound by arbitrage and seldom work over the short and medium terms. Similarly, the forward rate is not an unbiased predictor of future spot rate. However, PPP holds over reasonably long time horizons. If relative PPP holds at any point in time, the real exchange rate (i.e., the exchange rate adjusted for relative historical inflation between the currency pair) would be constant. However, since relative PPP seldom holds over the short term, the real exchange rate fluctuates around its mean-reverting equilibrium value.

The international Fisher effect (and real rate parity) assumes that there are no differences between sovereign risk premia (i.e., all countries are perceived to be equally risky by investors). This is obviously untrue as investors do demand a higher real rate of return (i.e., a risk premium) for investing in emerging market currencies that are perceived to be riskier.



MODULE QUIZ 5.2

1. Suppose the spot exchange rate quote is 1.0120 Canadian dollars (C\$) per U.S. dollar. The 1-year nominal interest rate in Canada is 3.0% and the 1-year nominal interest rate in the United States is 1.0%. The expected exchange rate at the end of the year using the uncovered interest rate parity is *closest* to:
 - A. C\$1.0322.
 - B. C\$0.9923.
 - C. C\$0.9918.
2. The international parity relationships indicate that the expected return on risk-free securities should be the same in all countries and exchange rate risk is really just inflation risk. Which of the following is *least likely* to be considered a practical implication of this framework?
 - A. Investors will earn the same real rate of return on investments once their own currency impact is accounted for.
 - B. Interest rate differentials reflect currency expectations. As a result, covered interest arbitrage will provide a return in any foreign currency that is equal to the domestic return.
 - C. There are significant rewards for bearing foreign exchange risk.
3. For uncovered interest rate parity to hold, which condition is necessary?
 - A. Forward rate parity holds.
 - B. Covered interest rate parity holds and ex-ante relative PPP holds.
 - C. Real interest rate parity and ex-ante relative PPP holds.

Use the following information to answer Questions 4 through 9.

Sally Franklin, CFA, is a financial advisor to Jamie Curtess, a U.S. citizen interested in learning more about how her investments will be affected by exchange rates and differences in interest rates internationally. Franklin has gathered the following information based on Curtess's investment interests.

The current spot exchange rate: \$1 = €0.74.

	Europe	United States
Nominal 1-year interest rate:	4%	?
Expected annual inflation:	2%	1%

Franklin also gathers the following information:

	Switzerland	South Africa
Nominal 1-year interest rate:	5%	7%
Expected annual inflation:	3%	5%

4. According to the international Fisher relation, the 1-year nominal interest rate in the United States should be *closest* to:
 - A. 3.00%.
 - B. 4.34%.
 - C. 6.00%.
5. If the relative form of the PPP holds, the expected exchange rate in one year is *closest* to:
 - A. \$1.3378 per €.
 - B. \$0.7463 per €.
 - C. \$1.3647 per €.
6. For this question only, assume that the U.S. interest rate is 3.5%. The 1-year forward rate should be *closest* to:
 - A. \$1.3647 per €.
 - B. \$0.7463 per €.

C. \$1.3449 per €.

7. Curtess wonders how spot rates are expected to change in the future and asks the following question: "What are the implications for the South African rand relative to the Swiss franc under uncovered interest rate parity, and the implications for the euro relative to the U.S. dollar under the relative form of purchasing power parity?" Franklin responds by making two statements:

Statement 1: The South African rand is expected to depreciate relative to the Swiss franc.

Statement 2: The euro is expected to depreciate relative to the U.S. dollar.

Based upon the underlying parity relationships cited, are Franklin's statements accurate?

A. No, both statements are inaccurate.

B. Yes, both statements are accurate.

C. One statement is accurate and one is inaccurate.

8. For this question only, imagine that the nominal interest rate in the United States is 3%. Real interest rates, using the Fisher relation, are *most likely* to be:

A. greater in the United States than in Europe.

B. lower in Europe than in South Africa.

C. equal among Europe, South Africa, Switzerland, and the United States.

9. A forecasted \$/€ exchange rate in one year equal to the current 1-year forward rate is *most likely* to be based on the assumption that:

A. absolute PPP holds.

B. investors are risk neutral.

C. real interest rate parity holds.

MODULE 5.3: EXCHANGE RATE DETERMINANTS, CARRY TRADE, AND CENTRAL BANK INFLUENCE



Video covering this content is available online.

LOS 5.i: Describe the carry trade and its relation to uncovered interest rate parity and calculate the profit from a carry trade.

FX Carry Trade

Uncovered interest rate parity states that a currency with a high interest rate should depreciate relative to a currency with a lower interest rate, so that an investor would earn the same return investing in either currency. For example, suppose that short-term interest rates are 3% in the U.K. and 1% in the United States. Uncovered interest rate parity implies that the GBP should depreciate by 2% relative to the USD over the coming year.

However, uncovered interest rate parity is not bound by arbitrage. If the GBP depreciates by less than 2% (or even appreciates), an investor who has invested in the higher yielding GBP using funds borrowed in USD will earn excess profits. In a **FX carry trade**, an investor invests in a higher yielding currency using funds borrowed in a lower yielding currency. The lower yielding currency is called the *funding currency*.

Consider the following example.

EXAMPLE: Carry trade

Interest Rates	Currency Pair	Exchange Rates	
		Today	One year later
U.K. 3%	USD/GBP	1.50	1.50
U.S. 1%			

Compute the profit to an investor borrowing in the United States and investing in the U.K.

Answer:

$$\begin{aligned}\text{return} &= \text{interest earned on investment} - \text{funding cost} \\ &\quad - \text{currency depreciation} \\ &= 3\% - 1\% - 0\% \\ &= 2\%\end{aligned}$$

The FX carry trade attempts to capture an interest rate differential and is a bet *against* uncovered interest rate parity. Carry trades typically perform well during low-volatility periods. Sometimes, higher yields attract larger capital flows, which in turn lead to an economic boom and appreciation (instead of depreciation) of the higher yielding currency. This could make the carry trade even more profitable because the investor earns a return from currency appreciation in addition to the return from the interest rate spread.

Risks of the Carry Trade

As discussed earlier, the carry trade is profitable only if uncovered interest rate parity does not hold over the investment horizon. The risk is that the funding currency may appreciate significantly against the currency of the investment, which would reduce a trader's profit—or even lead to a loss. Furthermore, the return distribution of the carry trade is not normal; it is characterized by negative **skewness** and excess **kurtosis** (i.e., fat tails), meaning that the probability of a large loss is higher than the probability implied under a normal distribution. We call this high probability of a large loss the **crash risk** of the carry trade.

Crash risk stems from the carry trade's leveraged nature: an investor borrows a low-yielding (funding) currency and then invests in a high-yielding currency. As more investors follow and adopt the same strategy, the demand for high-yielding currency actually pushes its value *up*. However, with this herding behavior comes the risk that all investors may attempt to exit the trade at the same time. (This is especially true if investors use stop-loss orders in their carry trades.) During turbulent times, as investors exit their positions (i.e., a flight to safety), the high-yielding currency can experience a steep decline in value, generating large losses for traders pursuing FX carry trades.

LOS 5.j: Explain how flows in the balance of payment accounts affect currency exchange rates.

Balance of Payments

Balance-of-payments (BOP) accounting is a method used to keep track of transactions between a country and its international trading partners. It includes government transactions, consumer transactions, and business transactions. The BOP accounts reflect all payments and liabilities *to* foreigners as well as all payments and obligations received *from* foreigners.

The **current account** measures the exchange of goods, the exchange of services, the exchange of investment income, and unilateral transfers (gifts to and from other nations). The current account balance summarizes whether we are selling more goods and services to the rest of the world than we are buying from them (a current account surplus) or buying more from the rest of the world than we are selling to them (a current account deficit).

The **financial account** (also known as the **capital account**) measures the flow of funds for debt and equity investment into and out of the country.

When a country experiences a current account deficit, it must generate a surplus in its capital account (or see its currency depreciate). Capital flows tend to be the dominant factor influencing exchange rates in the short term, as capital flows tend to be larger and more rapidly changing than goods flows.

Influence of BOP on Exchange Rates

Current Account Influences

Current account deficits lead to a depreciation of domestic currency via a variety of mechanisms:

- **Flow supply/demand mechanism.** Current account deficits in a country increase the supply of that currency in the markets (as exporters to that country convert their revenues into their own local currency). This puts downward pressure on the exchange value of that currency. The decrease in the value of the currency *may* restore the current account deficit to a balance—depending on the following factors:
 - *The initial deficit.* The larger the initial deficit, the larger the depreciation of domestic currency needed to restore current account balance.
 - *The influence of exchange rates on domestic import and export prices.* As a country's currency depreciates, the cost of imported goods increases. However, some of the increase in cost may not be passed on to consumers.
 - *Price elasticity of demand of the traded goods.* If the most important imports are relatively price inelastic, the quantity imported will not change.
- **Portfolio balance mechanism.** Countries with current account surpluses usually have capital account deficits, which typically take the form of investments in countries with current account deficits. As a result of these flows of capital, investor countries may find

their portfolios' composition being dominated by few investee currencies. When investor countries decide to rebalance their investment portfolios, it can have a significant negative impact on the value of those investee country currencies.

- **Debt sustainability mechanism.** A country running a current account deficit may be running a capital account surplus by borrowing from abroad. When the level of debt gets too high relative to GDP, investors may question the sustainability of this level of debt, leading to a rapid depreciation of the borrower's currency.

Capital Account Influences

Capital account flows are one of the major determinants of exchange rates. As capital flows into a country, demand for that country's currency increases, resulting in appreciation. Differences in real rates of return tend to be a major determinant of the flow of capital: higher relative real rates of return attract foreign capital. Capital flows into a country may be needed to overcome a shortage of internal savings to fund investments needed for economic growth. However, capital flows in excess of needed investment capital pose several problems. This is especially problematic for emerging markets.

Excessive capital inflows into emerging markets create problems for those countries such as:

- Excessive real appreciation of the domestic currency.
- Financial asset and/or real estate bubbles.
- Increases in external debt by businesses or government.
- Excessive consumption in the domestic market fueled by credit.

Emerging market governments often counteract excessive capital inflows by imposing capital controls or by direct intervention in the foreign exchange markets. We will discuss this further in a subsequent LOS.

LOS 5.k: Explain the potential effects of monetary and fiscal policy on exchange rates.

Mundell-Fleming Model

Developed in early 1960s, the **Mundell-Fleming model** evaluates the short-term impact of monetary and fiscal policies on interest rates—and consequently on exchange rates. The model assumes that there is sufficient slack in the economy to handle changes in aggregate demand, and that inflation is not a concern. Accordingly, changes in inflation rates due to changes in monetary or fiscal policy are not explicitly modeled by the Mundell-Fleming model.

We will look at the implications of this model for flexible exchange rate regimes as well as for fixed exchange rate regimes.

Flexible Exchange Rate Regimes

In a flexible (“floating”) exchange rate system, rates are determined by supply and demand in the foreign exchange markets. We will examine the influence of monetary and fiscal policies when international capital flows are relatively unrestricted (high mobility of capital)

versus when capital flows are relatively restricted (low mobility of capital), both under a flexible exchange rate system.

High Capital Mobility

Expansionary **monetary policy** and expansionary **fiscal policy** are likely to have opposite effects on exchange rates. Expansionary monetary policy will reduce the real interest rate and, consequently, reduce the inflow of capital investment in physical and financial assets. This decrease in financial inflows (deterioration of the financial account) reduces the demand for the domestic currency, resulting in depreciation of the domestic currency. Restrictive monetary policy should have the opposite effect, increasing real interest rates and leading to an appreciation in the value of the domestic currency.

Expansionary fiscal policy (an increased deficit from lower taxes or higher government spending) will increase government borrowing and, consequently, real interest rates. An increase in real interest rates will attract foreign investment, improve the financial account, and consequently, *increase* the demand for the domestic currency.

Low Capital Mobility

Our discussion so far has assumed free flow of capital, which is a valid assumption with respect to developed markets. In emerging markets, however, capital flows may be restricted. In that case, the impact of trade imbalance on exchange rates (goods flow effect) is greater than the impact of interest rates (financial flows effect). In such a case, expansionary fiscal or monetary policy leads to increases in net imports, leading to depreciation of the domestic currency. Similarly, restrictive monetary or fiscal policy leads to an appreciation of domestic currency. Figure 5.2 summarizes the influence of fiscal and monetary policy on the value of the domestic currency.

Figure 5.2: Monetary and Fiscal Policy vs. the Value of the Domestic Currency

Monetary Policy/Fiscal Policy	Capital Mobility	
	High	Low
Expansionary/Expansionary	Uncertain	Depreciation
Expansionary/Restrictive	Depreciation	Uncertain
Restrictive/Expansionary	Appreciation	Uncertain
Restrictive/Restrictive	Uncertain	Appreciation



PROFESSOR'S NOTE

Candidates are often confused by the implication under the Mundell-Fleming model that a higher-interest-rate currency will appreciate relative to a lower-interest-rate currency, because this is exactly the opposite of what we learned under uncovered interest rate parity. Note, though, that uncovered interest rate parity assumed that real interest rates are equal globally, and thus that nominal interest rates merely mirror expected inflation. That condition no longer holds under the Mundell-Fleming model, which does not consider inflation.

Fixed Exchange Rate Regimes

Under a fixed exchange rate regime, the government fixes the rate of exchange of its currency relative to one of the major currencies.

An expansionary (restrictive) monetary policy would lead to depreciation (appreciation) of the domestic currency as stated previously. Under a fixed rate regime, the government would then have to purchase (sell) its own currency in the foreign exchange market. This action essentially reverses the expansionary (restrictive) stance.

This explains why, in a world with mobility of capital, governments cannot both manage exchange rates as well as pursue independent monetary policy. If the government wants to manage monetary policy, it must either let exchange rates float freely or restrict capital movements to keep them stable.

Monetary Approach to Exchange Rate Determination

Monetary models only take into account the effect of monetary policy on exchange rates (fiscal policy effects are not considered). With the Mundell-Fleming model, we assume that inflation (price levels) plays no role in exchange rate determination. Under monetary models, we assume that output is fixed, so that monetary policy primarily affects inflation, which in turn affects exchange rates. There are two main approaches to monetary models:

1. **Pure monetary model.** Under a pure monetary model, the PPP holds at any point in time and output is held constant. An expansionary (restrictive) monetary policy leads to an increase (decrease) in prices and a decrease (increase) in the value of the domestic currency. Therefore an $x\%$ increase in the money supply leads to an $x\%$ increase in price levels and then to an $x\%$ depreciation of domestic currency. The pure monetary approach does not take into account expectations about future monetary expansion or contraction.
2. **Dornbusch overshooting model.** This model assumes that prices are sticky (inflexible) in the short term and, hence, do not immediately reflect changes in monetary policy (in other words, PPP does not hold in the short term). The model concludes that exchange rates will overshoot the long-run PPP value in the short term. In the case of an expansionary monetary policy, prices increase, but over time. Expansionary monetary policy leads to a *decrease* in interest rates—and a larger-than-PPP-implied depreciation of the domestic currency due to capital outflows. In the long term, exchange rates gradually increase toward their PPP implied values.

Similarly, a restrictive monetary policy leads to excessive appreciation of the domestic currency in the short term, and then a slow depreciation toward the long-term PPP value.

Portfolio Balance Approach to Exchange Rate Determination

The portfolio balance approach focuses only on the effects of *fiscal* policy (and not monetary policy). While the Mundell-Fleming model focuses on the short-term implications of fiscal policy, the **portfolio balance approach** takes a long-term view and evaluates the effects of a sustained fiscal deficit or surplus on currency values.

When the government runs a fiscal deficit, it borrows money from investors. Under the portfolio balance approach, investors evaluate the debt based on expected risk and return. A sovereign debt investor would earn a return based on both the debt's yield and its currency return. (When we invest in a foreign-currency-denominated security, our realized return will be comprised of the return earned on that security in its local currency, as well

as a return from the performance of that foreign currency versus our domestic currency.) When a government pursues a long-term stance of expansionary fiscal policy, an investor should evaluate the implications of such a policy on expected risk and return (typically the yield should increase due to a higher risk premium). If investors perceive that the yield and/or currency return is sufficient, they will continue to purchase the bonds. However, continued increases in fiscal deficits are unsustainable and investors may refuse to fund the deficits—leading to currency depreciation.

Combining the Mundell-Fleming and portfolio balance approaches, we find that in the short term, with free capital flows, an expansionary fiscal policy leads to domestic currency appreciation (via high interest rates). In the long term, the government has to reverse course (through tighter fiscal policy) leading to depreciation of the domestic currency. If the government does not reverse course, it will have to monetize its debt (i.e., print money—monetary expansion), which would also lead to depreciation of the domestic currency.

LOS 5.I: Describe objectives of central bank or government intervention and capital controls and describe the effectiveness of intervention and capital controls.

A combination of “push” and “pull” factors determine the flow of capital into a country. Pull factors are favorable developments that make a country an attractive destination for foreign capital. These include relative price stability, a flexible exchange rate regime, improved fiscal position, privatization of state-owned enterprises etc. Push factors are largely driven by mobile international capital seeking high returns from a diversified portfolio.

As stated earlier, capital flows can lead to excessive appreciation of a currency. This can lead to several problems including loss of competitiveness of exports in the global markets, asset price bubbles, and excessive consumption fueled by credit creation. Excessive capital inflows to a country can also lead to a currency crisis when such capital is eventually withdrawn from the country. To reduce these problems, policymakers may intervene by imposing capital controls or by direct intervention in the foreign exchange market by the central bank.

Objectives

The objectives of capital controls or central bank intervention in FX markets are to:

- Ensure that the domestic currency does not appreciate excessively.
- Allow the pursuit of independent monetary policies without being hindered by their impact on currency values. For example, an emerging market central bank seeking to reduce inflation may pursue a restrictive monetary policy, increasing interest rates. However, these higher rates may attract large inflows of foreign capital, pushing up the value of the domestic currency.
- Reduce the aggregate volume of inflow of foreign capital.

Effectiveness

For developed market countries, the volume of trading in a country’s currency is usually very large relative to the foreign exchange reserves of its central bank. Evidence has shown

that for developed markets, central banks are relatively ineffective at intervening in the foreign exchange markets due to lack of sufficient resources. Evidence in the case of emerging markets is less clear: central banks of emerging market countries may be able to accumulate sufficient foreign exchange reserves (relative to trading volume) to affect the supply and demand of their currencies in the foreign exchange markets.

LOS 5.m: Describe warning signs of a currency crisis.

History has shown that market participants have failed to predict crises and typically are surprised by them. When market sentiment changes significantly, crises may occur *even for countries with sound economic fundamentals*.

The following conditions have been identified as warning signs in the period leading up to a currency crisis:

- Terms of trade (i.e., ratio of exports to imports) deteriorate.
- Fixed or partially-fixed exchange rates (versus floating exchange rates).
- Official foreign exchange reserves dramatically decline.
- Currency value that has risen above its historical mean.
- Inflation increases.
- Liberalized capital markets, that allow for the free flow of capital.
- Money supply relative to bank reserves increases.
- Banking crises (may also be coincident).



MODULE QUIZ 5.3

1. Vilasram Deshmukh is forecasting JPY/USD exchange rates based on balance of payments analysis. He notes that the United States is running large current account deficits relative to Japan. Based on this information, he concludes that the JPY/USD rate should decrease. His conclusion is *most likely* supported by the:
 - A. flow mechanism of the current account influences.
 - B. portfolio composition mechanism of the current account influences.
 - C. capital account influences.
2. Stephen Hall is forecasting USD/GBP exchange rates. He consults forecasts of the money supply for the United States and U.K. made by his firm's chief economist, and he notes the following statement from a report published by the chief economist: "The U.S. money supply is expected to grow at a much faster pace than the U.K. or European money supplies."

Hall makes the following statement: "Under the pure monetary approach model, an increase in the future growth rate of the money supply would lead to an immediate depreciation in the currency's value." Hall's statement is *most likely*:

- A. correct.
 - B. incorrect, as the future growth rate in the money supply would not immediately affect currency values under the pure monetary approach model.
 - C. incorrect, as the future growth rate in money supply would actually increase the currency value under the pure monetary approach.
3. Chintan Rajyaguru works for a currency dealer in London. He is evaluating the implications of changes in fiscal and monetary policies occurring in Zambola, an emerging market country with low capital mobility. He concludes that Zambola's central bank is pursuing a restrictive

monetary policy to curb inflation. Additionally, the Zambolan government has been reducing budget deficits to comply with new IMF lending terms. According to the Mundell-Fleming model, the change in monetary and fiscal policy is *most likely* to cause the Zambolan currency to:

- A. appreciate.
- B. depreciate.
- C. remain unchanged.

Use the following information to answer Questions 4 through 9.

Agnetha Poulsen works as an analyst in the foreign exchange overlay strategies department for CFN, a large asset management firm serving institutional clients. She is concerned about the excessive unhedged currency exposure taken on by the overlay strategies department. She makes an appointment with Alvilda Kristensen, director of risk management, to discuss this matter. Prior to the meeting, Poulsen collects information on foreign currency quotes and on interest rates as shown in Figure 1 and Figure 2.

Figure 1: Current Spot and Forward Exchange Rate Quotes

Quotes	USD/CHF	USD/EUR
Spot	0.9817/0.9821	1.2235/1.2238
30-day forward	-7.6/-6.9	-7.21/-6.80
60-day forward	-15.3/-13.3	-14.56/-13.76
90-day forward	-24.3/-23.05	-23.84/-22.77

Figure 2: Selected Interest Rates

Interest Rates	USD	EUR	CHF
30-day rate	0.20%	0.91%	1.13%
60-day rate	0.21%	0.93%	1.15%
90-day rate	0.26%	1.04%	1.25%

Poulsen also reviews the current open forward contracts. As an example, she reviews two contracts. Contract FX2001 is a 90-day forward contract initiated 60 days ago. The contract calls for purchase of CHF 200 million at an all-in rate of USD 0.9832. Contract FX2051 is a 90-day contract initiated 30 days ago to purchase 100 million EUR at an all-in rate of 1.2242.

During her meeting with Kristensen, Poulsen expresses concern about traders establishing FX carry trades in several emerging market currencies. Kristensen assures Poulsen that CFN has adequate monitoring mechanisms. She continues that these carry trades have been generating significant positive returns for the clients and Poulsen should not worry about it. Poulsen counters by stating that carry trade returns distributions are characterized by negative kurtosis and excess skewness.

Poulsen reviews her notes and decides to prepare a report on currency crises. She compiles a list of indicators of an impending currency crisis based on empirical analysis.

Poulsen then turns her attention to the firm's investments in Zambola, an emerging market. She realizes that currently the currency overlay strategy department has no trades involving the free-floating Zambolan currency, the Zu. Poulsen is concerned about significant long exposure of the portfolio in Zu. Zambola is enjoying large capital inflows drawn by Zambola's attractive yields. Her analysis indicates that Zambola has been running large current account deficits. A trend analysis on Zu indicates a steep upward trend continuing above its PPP value.

1. The 30-day forward spread on USD/CHF is *closest* to:
 - A. 0.0005.
 - B. 0.0007.
 - C. 0.7000.
2. The current mark-to-market value of the forward contract FX2001 in USD is *closest* to:
 - A. -USD460,000.
 - B. -USD451,924.
 - C. -USD357,940.
3. The current mark-to-market value of the forward contract FX2051 in USD is *closest* to:
 - A. -USD215,900.
 - B. -USD107,900.
 - C. -USD216,000.
4. Poulsen's description of the carry trade return distribution is *best* described as:
 - A. correct.
 - B. incorrect about skewness only.
 - C. incorrect about both skewness and kurtosis.
5. Which of the following indicators of impending currency crises should Poulsen exclude from her report?
 - A. Terms of trade improve.
 - B. Increase in money supply relative to bank reserves.
 - C. Increase in inflation.
6. If Zambolan government wanted to reduce the inflow of foreign capital, it should:
 - A. pursue expansionary monetary policies.
 - B. pursue policies consistent with currency appreciation.
 - C. reduce inflation by increasing interest rates.

KEY CONCEPTS

LOS 5.a

bid-ask spread (for base currency) = ask quote - bid quote

Dealer spreads depend on spreads in the interbank market, the transaction size, and the dealer-client relationship. Interbank spreads depend on the currencies involved, time of day, and volatility in the currency pair. Forward spreads increase with maturities.

LOS 5.b

To calculate the profits from triangular arbitrage, start in the home currency and go around the triangle by exchanging the home currency for the first foreign currency, then exchanging the first foreign currency for the second foreign currency, and then exchanging the second foreign currency back into the home currency. If we end up with more money

than what we had when we started, we've earned an arbitrage profit. The bid-ask spread forces us to buy a currency at a higher rate going one way than we can sell it for going the other way.

LOS 5.c

A spot exchange rate is for immediate delivery, while a forward exchange rate is for future delivery.

premium (discount) for base currency = forward price – spot price

LOS 5.d

The mark-to-market value of a forward contract reflects the profit that would be realized by closing out the position at current market prices, which is equivalent to offsetting the contract with an equal and opposite forward position:

$$V_t = \frac{(FP_t - FP)(\text{contract size})}{\left[1 + R\left(\frac{\text{days}}{360}\right)\right]}$$

where:

V_t = value of the forward contract at time t (to the party buying the base currency), ($t < T$) denominated in price currency

FP_t = forward price (to sell base currency) at time t in the market for a new contract maturing at time T

FP = forward price specified in the contract at inception (to buy the base currency)

days = number of days remaining to maturity of the forward contract ($T - t$)

R = interest rate of price currency

LOS 5.e

Covered interest arbitrage:

$$F = \frac{\left[1 + R_A\left(\frac{\text{days}}{360}\right)\right]}{\left[1 + R_B\left(\frac{\text{days}}{360}\right)\right]} S_0$$

Uncovered interest rate parity:

$$E(\% \Delta S)_{(A/B)} = R_A - R_B$$

International Fisher relation:

$$R_{\text{nominal A}} - R_{\text{nominal B}} = E(\text{inflation}_A) - E(\text{inflation}_B)$$

Relative PPP:

$$\% \Delta S_{(A/B)} = \text{inflation}_A - \text{inflation}_B$$

Forward rate parity:

$$F = E(S_T)$$

LOS 5.f

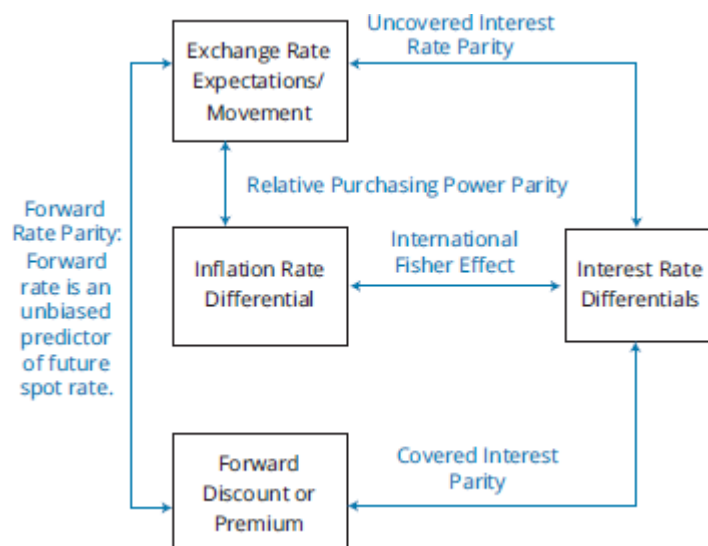

LOS 5.g, 5.h

Future spot rates can be forecasted using PPP or by uncovered interest rate parity. However, neither relationship is bound by arbitrage, nor do these relationships necessarily work in the short term. Forward exchange rates, on the other hand, can be estimated using covered interest parity, and this relationship is bound by arbitrage. If uncovered interest parity holds, then we say that the forward rate parity holds, i.e., the forward rate is an unbiased estimate of the future spot rate.

LOS 5.i

The FX carry trade seeks to profit from the failure of uncovered interest rate parity to work in the short run. In an FX carry trade, the investor invests in a high-yielding currency while borrowing in a low-yielding currency. If the higher yielding currency does not depreciate by the interest rate differential, the investor makes a profit. Carry trade has exposure to crash risk.

profit on carry trade = interest differential – change in the spot rate of the investment currency

LOS 5.j

BOP influence on exchange rate can be analyzed based on current account influence and capital account influence. Current account influences include flow mechanism, portfolio composition mechanism, and debt sustainability mechanism. Capital account inflows (outflows) are one of the major causes of increases (decreases) in exchange rates.

LOS 5.k

The Mundell-Fleming model of exchange rate determination evaluates the impact of monetary and fiscal policies on interest rates and consequently on exchange rates.

Under monetary models, we assume that output is fixed and, hence, monetary policies primarily affect inflation, which in turn affects exchange rates.

The portfolio balance (asset market) model evaluates the long-term implications of sustained fiscal policy (deficit or surplus) on currency values.

Monetary and Fiscal Policy and Exchange Rates

Monetary Policy/Fiscal Policy	Capital Mobility	
	High	Low
Expansionary/Expansionary	Uncertain	Depreciation
Expansionary/Restrictive	Depreciation	Uncertain
Restrictive/Expansionary	Appreciation	Uncertain
Restrictive/Restrictive	Uncertain	Appreciation

Under the pure monetary approach, PPP holds at any point in time.

Under the Dornbusch overshooting model, a restrictive (expansionary) monetary leads to an appreciation (depreciation) of domestic currency in the short term, and then slow depreciation (appreciation) towards the long-term PPP value.

Combining the Mundell-Fleming and portfolio balance approaches, we find that in the short term, an expansionary (restrictive) fiscal policy leads to domestic currency appreciation (depreciation). In the long term, the impact on currency values is opposite.

LOS 5.l

Capital controls and central bank intervention aim to reduce excessive capital inflows, which could lead to speculative bubbles. The success of central bank intervention depends on the size of official FX reserves at the disposal of the central bank relative to the average trading volume in the country's currency. For developed markets, the central bank resources on a relative basis are too insignificant to be effective at managing exchange rates. However, some emerging market countries with large FX reserves relative to trading volume have been somewhat effective.

LOS 5.m

Warning signs of currency crises include: deterioration in terms of trade, a dramatic decline in official foreign exchange reserves, an exchange rate substantially higher than its mean-reverting level, increases in the inflation rate, a fixed- or partially-fixed exchange rate, an increase in money supply relative to bank reserves, and banking crises.

ANSWER KEY FOR MODULE QUIZZES

Module Quiz 5.1

- C** Dealer spreads are lower for smaller orders as compared to larger orders. Dealer spreads are larger when spreads in the interbank market are higher. An increase in spot rate volatility will increase spreads in the interbank market. (LOS 5.a)
- C** Here is what the triangle looks like with the bid–ask quotes filled in:

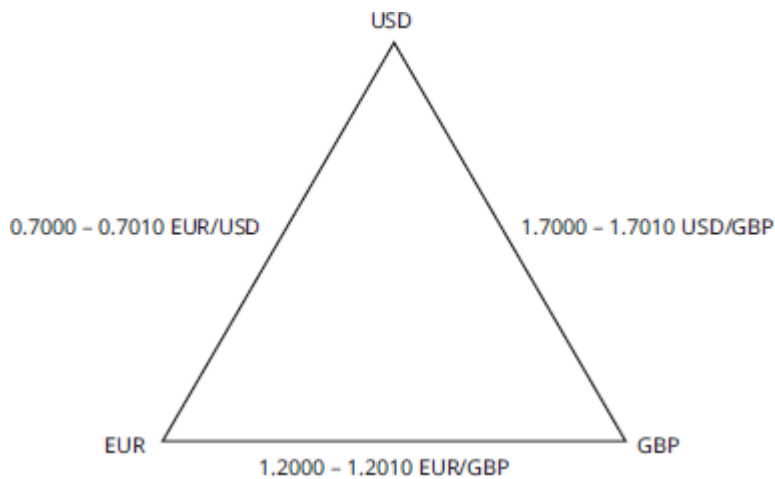

If we start with 1 million USD and move clockwise around the triangle (USD to GBP to EUR to USD), we first convert 1 million USD into GBP at the ask:

$$\frac{1 \text{ million USD}}{1.7010 \text{ USD/GBP}} = 587,889 \text{ GBP}$$

Then we sell the GBP for EUR at the bid:

$$587,889 \text{ GBP} \times \left(\frac{1.2000 \text{ EUR}}{\text{GBP}} \right) = 705,467 \text{ EUR}$$

Finally, we purchase USD at the ask in euros:

$$\frac{705,467 \text{ EUR}}{0.7010} = 1,006,372 \text{ USD}$$

Arbitrage profits are $1,006,372 \text{ USD} - 1,000,000 \text{ USD} = 6,372 \text{ USD}$. (LOS 5.b)

Module Quiz 5.2

1. **A** Because of a lower interest rate, the USD (base currency) will appreciate by 2% to $\$1.012 \times 1.02 = \text{C}\1.0322 . (LOS 5.e)
2. **C** Combining all parity relationships indicates that the expected return on risk-free securities should be the same in all countries and exchange rate risk is really just inflation risk. There are four practical implications from this framework:
 1. The real, risk-free return will be the same in all countries.
 2. Investing in countries with high nominal interest rates will not generate excess returns because the high nominal interest rates will be accompanied by local currency depreciation.
 3. All investors will earn the same expected return in their own currency on any investment denominated in a foreign currency.
 4. Exchange rate risk is simply inflation risk, so investors interested in real returns will not face exchange rate risk.

(LOS 5.f)
3. **A** Covered interest parity is forced by arbitrage, which is not the case for uncovered interest rate parity. If the forward rate is equal to the expected future spot rate, we say that the forward rate is an unbiased predictor of the future spot rate: $F = E(S_1)$. In this special case, given that covered interest parity holds, uncovered interest parity

would also hold (and vice versa). In other words, if uncovered interest rate parity (and covered interest parity) holds, the forward rate is unbiased predictor of future spot rate (i.e., forward rate parity holds). (LOS 5.e)

4. **A** According to the international Fisher relation:

$$r = \text{real } r + E(I)$$

From European data:

$$4\% = \text{real } r + 2\%$$

$$\text{real } r = 2\%$$

For United States:

$$r = 2\% + 1\%$$

$$r = 3\%$$

(LOS 5.e)

5. **A** Since inflation in Europe is higher than the inflation in the U.S. by 1%, the Euro is expected to depreciate by 1% annually against the dollar.

The current spot rate is $\$(1/0.74)$ per Euro or $\$1.3513/\text{€}$.

expected exchange rate in 1 year = $1.3513(0.99) = \$1.3378/\text{€}$

(LOS 5.e)

6. **C** Using covered interest parity, the forward rate in one year (in \$ per €) can be calculated as follows:

Spot rate = $\text{€}0.74$ per $\$ = \$(1 / 0.74)$ per €

$$F = S_0 \times \left(\frac{1 + r_{\$}}{1 + r_{\text{€}}} \right) = \left(\frac{1}{0.74} \right) \times \left(\frac{1.035}{1.04} \right) = \$1.3449 \text{ per } \text{€}$$

(LOS 5.e)

7. **B** Franklin is correct with respect to both of his statements: the rand should depreciate relative to the franc and the euro should depreciate relative to the dollar.

The relative form of purchasing power parity predicts that countries with higher expected inflation will experience a depreciation of their currencies. South Africa's expected inflation rate (5%) is higher than the expected inflation rate in Switzerland (3%). The expected inflation rate in Europe (2%) is higher than the expected inflation rate in the United States (1%). According to purchasing power parity, the rand should depreciate relative to the franc, and the euro should depreciate relative to the U.S. dollar.

Uncovered interest parity makes the same predictions with regard to relative interest rates: countries with higher nominal interest rates can be expected to experience currency depreciation. The South African interest rate (7%) is higher than the Swiss rate (5%), so uncovered interest rate parity predicts that the rand will depreciate with respect to the franc. The interest rate in Europe (4%) is higher than the interest rate in the United States (3%), so the euro should depreciate relative to the U.S. dollar.

(LOS 5.e)

8. **C** According to the international Fisher relation, the real interest rate is equal to the nominal interest rate minus the expected inflation rate. The real interest rate in each of the four countries is 2%. (LOS 5.e)
9. **B** The 1-year expected spot rate should be equal to the current 1-year forward rate if uncovered interest rate parity holds. One of the assumptions of uncovered interest rate parity is that investors are risk neutral. Real interest rate parity states that real interest rates are equal across countries. Uncovered interest rate parity also would hold if both (1) relative (not absolute) PPP holds and (2) the international Fisher relationship holds. (LOS 5.e)

Module Quiz 5.3

1. **A** The flow mechanism of current account influences supports the view that current account deficits lead to depreciation of currency. In this example, the reduction in the JPY/USD rate implies depreciation of the USD. Under capital account influences, current account deficits imply capital account inflows and, hence, would lead to an appreciation of USD. The portfolio composition mechanism of current account influences supports the flow mechanism if investors rebalance a portion of their portfolio out of USD assets due to gradual buildup of USD assets over time in their portfolios. The question does not provide information to support this reallocation. (Module 5.3, LOS 5.j)
2. **B** Under the pure monetary approach, growth in the money supply leads to depreciation in currency. However, the future growth rate in money supply affects the trajectory of FX rates but not the current exchange rate. (Module 5.3, LOS 5.k)
3. **A** Under the Mundell-Fleming framework, low capital mobility and restrictive monetary and fiscal policy leads to better trade balance and appreciation of the country's currency. (Module 5.3, LOS 5.k)
4. **A** $(0.9821 - 0.00069) - (0.9817 - 0.00076) = 0.00047$
(Module 5.1, LOS 5.c)
5. **B** The contract calls for purchase of 200 million CHF in 30 days. To compute the mark-to-market value, we would have to use the quote on 30-day forward contract to sell CHF. Given USD/CHF quote structure, we should use the bid price (going up the quote).

all-in bid price for 30-day USD/CHF forward contract =
 $0.9817 - 7.6 / 10,000 = 0.98094$

$$V_t = \frac{(FP_t - FP)(\text{contract size})}{\left[1 + R \left(\frac{\text{days}}{360}\right)\right]}$$

$FP_t = 0.98094$ (computed above)

$FP = 0.9832$ (given)

$R = 30\text{-day USD interest rate (USD is the price currency)}$
 $= 0.20\%$

$$V_t = \frac{(0.98094 - 0.9832)(200,000,000)}{\left[1 + 0.002 \left(\frac{30}{360}\right)\right]} = \frac{-452,000}{1.000166} = -451,924 \text{ USD}$$

(Module 5.2, LOS 5.d)

6. **A** The contract calls for purchase of 100 million EUR in 60 days. To compute the mark-to-market value, we would have to use the quote on 60-day forward contract to sell EUR. Given USD/EUR quote structure, we should use the bid price (going up the quote).

all-in bid price for 60-day USD/EUR forward contract = $1.2235 - 14.56 / 10,000 = 1.22204$

$$V_t = \frac{(FP_t - FP)(\text{contract size})}{\left[1 + R \left(\frac{\text{days}}{360}\right)\right]}$$

$FP_t = 1.22204$ (computed above)

$FP = 1.2242$ (given)

$R = 60\text{-day USD interest rate (USD is the price currency)}$
 $= 0.21\%$

$$V_t = \frac{(1.22204 - 1.2242)(100,000,000)}{\left[1 + 0.0021 \left(\frac{60}{360}\right)\right]} = \frac{-216,000}{1.00035} = -215,924 \text{ USD}$$

(Module 5.2, LOS 5.d)

7. **C** Poulsen incorrectly described both the skewness as well as the kurtosis of carry trade returns. Carry trade return distributions generally have *negative skewness* and *excess kurtosis*. (Module 5.3, LOS 5.i)
8. **A** Deterioration (and not improvement) in terms of trade is an indicator of currency crisis. (Module 5.3, LOS 5.m)
9. **A** The Zu is overvalued per PPP, and Zambola is running a current account deficit. A depreciation of Zu would bring it closer to its long-run fair value. An increase in interest rates would lead to appreciation of Zu. Expansionary monetary policy would reduce interest rates and make Zambolan yields less attractive to foreign investors. (Module 5.3, LOS 5.j)

READING 6

ECONOMIC GROWTH

EXAM FOCUS

Forecasts of economic growth rates have important implications for investment decisions. Understand the preconditions of growth, how the growth rate can be increased, and what drives economic growth. Be able to compare and contrast competing theories of growth. Finally, be able to use growth accounting equations to forecast the potential growth rate of an economy.

MODULE 6.1: GROWTH FACTORS AND PRODUCTION FUNCTION



Video covering this content is available online.

LOS 6.a: Compare factors favoring and limiting economic growth in developed and developing economies.

Economists measure the economic output of a country by gross domestic product (GDP). A country's standard of living, however, is best measured by GDP per capita. Of particular concern to investors is not just the level of economic output but the growth rate of output.

Historically, there have been large variations in both GDP growth rates and per capita GDP across countries. Research has identified several factors that influence both the growth of GDP and the level of GDP.

Preconditions for Growth

1. **Savings and investment** are positively correlated with economic development. For countries to grow, private and public sector investment must provide a sufficient level of capital per worker. If a country has insufficient domestic savings, it must attract foreign investment in order to grow.
2. **Financial markets and intermediaries** augment economic growth by efficiently allocating resources in several ways. First, financial markets determine which potential users of capital offer the best returns on a risk-adjusted basis. Second, financial instruments are created by intermediaries that provide investors with liquidity and opportunities for risk reduction. Finally, by pooling small amounts of savings from investors, intermediaries can finance projects on larger scales than would otherwise be possible.

Some caution is in order, however. Financial sector intermediation may lead to declining credit standards and/or increases in leverage, increasing risk but not economic growth.

3. The **political stability, rule of law, and property rights** environment of a country also influence economic growth. Countries that have not developed a system of property rights for both physical and intellectual property will have difficulty attracting capital. Similarly, economic uncertainty caused by wars, corruption, and other disruptions poses unacceptable risk to many investors, reducing potential economic growth.
4. **Investment in human capital**, the investment in skills and well-being of workers, is thought to be complementary to growth in physical capital. Consequently, countries that invest in education and health care systems tend to have higher growth rates. Developed countries benefit the most from post-secondary education spending, which has been shown to foster innovation. Less-developed countries benefit the most from spending on primary and secondary education, which enables the workforce to *apply* the technology developed elsewhere.
5. **Tax and regulatory systems** need to be favorable for economies to develop. All else equal, the lower the tax and regulatory burdens, the higher the rate of economic growth. Lower levels of regulation foster entrepreneurial activity (startups), which have been shown to be positively related to the overall level of productivity.
6. **Free trade and unrestricted capital flows** are also positively related to economic growth. Free trade promotes growth by providing competition for domestic firms, thus increasing overall efficiency and reducing costs. Additionally, free trade opens up new markets for domestic producers. Unrestricted capital flows mitigate the problem of insufficient domestic savings as foreign capital can increase a country's capital, allowing for greater growth. Foreign capital can be invested directly in assets such as property, physical plant, and equipment (foreign direct investment), or invested indirectly in financial assets such as stocks and bonds.

LOS 6.b: Describe the relation between the long-run rate of stock market appreciation and the sustainable growth rate of the economy.

Equity prices are positively related to earnings growth. Economy-wide, aggregate corporate earnings can grow if GDP grows or if the share of corporate earnings in GDP grows. However, the share of corporate profits in the GDP cannot increase indefinitely, because labor will be unwilling to work for a lower and lower proportion of the GDP. Therefore, the **potential GDP** of a country—the upper limit of *real* growth for an economy—is the long-run limit of earnings growth, and is an important factor in predicting returns on aggregate equity markets.

The Grinold-Kroner (2002) model provides the appropriate framework to understand this:

$$E(R) = \text{dividend yield (DY)} + \text{expected capital gains yield (CGY)}$$

We can further decompose the capital gains yield into EPS growth and growth in the P/E ratio:

$$\text{expected capital gains yield} = \text{EPS growth } (\Delta \text{EPS}) + \text{expected repricing } (\Delta P/E)$$

EPS growth can be decomposed into real EPS growth, inflation, and change in the number of shares outstanding via stock buybacks (i.e., the dilution effect).

$$\text{EPS growth} = \text{real EPS growth } (\Delta\text{EPS}_R) + \text{inflation } (\pi) - \text{change in shares outstanding } (\Delta S)$$

The full model then is:

$$E(R) = DY + \Delta\text{EPS}_R + \pi - \Delta S + \Delta P/E$$

Dividend yield tends to be stable over time. The repricing term (change in P/E) does fluctuate with the business cycle: when GDP growth is high, market multiples rise as perception of risk declines. The repricing term, however, cannot continue to grow. Therefore, in the long-run, the key factor driving equity returns is ΔEPS_R which is itself subject to an upper limit of potential GDP growth.

The dilution effect (ΔS) sometimes plays a role in determining equity returns, but its impact differs by country depending on its level of development and the sophistication of its financial markets. Recognize that on an aggregate basis, the dilution effect is comprised of net stock buybacks (nbb) as well as issuance by privately held small and medium entrepreneurial companies (it would actually be more appropriate to call *nbb* “net issuance,” where net issuance = new issuance – buybacks). We call the role of these small and medium entrepreneurial companies the **relative dynamism (rd)** of the economy.

$$\text{Therefore, } \Delta S = \text{nbb} + \text{rd}$$

Relative dynamism captures the difference between the overall economic growth of the country and the earnings growth of listed companies.

LOS 6.c: Explain why potential GDP and its growth rate matter for equity and fixed income investors.

As indicated earlier, all else equal, higher GDP growth will be associated with higher equity returns. However, equity returns are significantly affected by dilution (due to share buybacks, mergers, privatizations of public companies, etc.). Economic growth can also be attributed to privately held companies. Potential GDP also has implications for real interest rates. Positive growth in potential GDP indicates that future income will rise relative to current income. When consumers expect their incomes to rise, they increase current consumption and save less for future consumption (i.e., they are less likely to worry about funding their future consumption). To encourage consumers to delay consumption (i.e., to encourage savings), investments would have to offer a higher real rate of return. Therefore, higher potential GDP growth implies higher real interest rates and higher real asset returns in general.

In the short term, the relationship between actual GDP and potential GDP may provide insight to both equity and fixed-income investors as to the state of the economy. For example, since actual GDP in excess of potential GDP results in rising prices, the gap between the two can be used as a forecast of inflationary pressures—useful to all investors but of particular concern to fixed-income investors. Furthermore, central banks are likely to adopt monetary policies consistent with the gap between potential output and actual output. When actual GDP growth rate is higher (lower) than potential GDP growth rate,

concerns about inflation increase (decrease) and the central bank is more likely to follow a restrictive (expansionary) monetary policy.

In addition to predicting monetary policy, the relationship between actual and potential GDP can also be useful in analyzing fiscal policies. It is more likely for a government to run a fiscal deficit when actual GDP growth rate is lower than its potential growth rate.

Finally, because of the credit risk assumed by fixed-income investors, growth in GDP may be used to gauge credit risk of both corporate and government debt. A higher potential GDP growth rate reduces expected credit risk and generally increases the credit quality of all debt issues.

LOS 6.d: Contrast capital deepening investment and technological progress and explain how each affects economic growth and labor productivity.

Factor Inputs and Economic Growth

Economies are complex systems of many economic inputs. To simplify analysis, we examine a 2-factor (labor and capital) aggregate production function in which output (Y) is a function of labor (L) and capital (K), given a level of technology (T).

To examine the effect of capital investment on **economic growth** and **labor productivity**, consider a **Cobb-Douglas production function**, which takes the form:

$$Y = TK^{\alpha}L^{(1-\alpha)}$$

where:

α and $(1 - \alpha)$ = the share of output allocated to capital (K) and labor (L), respectively [α and $(1 - \alpha)$ are also referred to as capital's and labor's share of total factor cost, where $\alpha < 1$]

T = a scale factor that represents the **technological progress** of the economy, often referred to as *total factor productivity (TFP)*

The Cobb-Douglas function essentially states that output (GDP) is a function of labor and capital inputs and their productivity. It exhibits **constant returns to scale**; increasing both inputs by a fixed percentage leads to the same percentage increase in output.

Dividing both sides by L in the Cobb-Douglas production function, we can obtain the output per worker (labor productivity).

$$\text{output per worker} = Y/L = T(K/L)^{\alpha}$$

Labor productivity is similar to GDP per capita, a standard of living measure. The previous equation has important implications about the effect of capital investment on the standard of living. Assuming the number of workers and α remain constant, increases in output can be gained by increasing capital per worker (**capital deepening**) or by improving technology (increasing TFP).

However, since α is less than one, additional capital has a diminishing effect on productivity: the lower the value of α , the lower the benefit of capital deepening. Developed markets typically have a high capital to labor ratio and a lower α compared to

developing markets, and therefore developed markets stand to gain less in increased productivity from capital deepening.



PROFESSOR'S NOTE

We need to distinguish between marginal product of capital and marginal productivity of capital. Marginal product of capital is the additional output for one additional unit of capital. Marginal productivity of capital is the increase in output per worker for one additional unit of capital per labor (i.e., increasing capital while keeping labor constant).

In steady state (i.e., equilibrium), the marginal product of capital ($MPK = \alpha Y/K$) and marginal cost of capital (i.e., the *rental price of capital*, r) are equal; hence:

$$\alpha Y/K = r$$

or

$$\alpha = rK/Y$$



PROFESSOR'S NOTE

In the previous equation, r is rate of return and K is amount of capital. rK measures the amount of return to providers of capital. The ratio of rK to output (Y) measures the amount of output that is allocated to providers of capital. This is precisely our definition of α .

The productivity curves in Figure 6.1 show the effect of increasing capital per worker on output per worker. Capital deepening is a movement *along* the productivity curve. The curvature of the relationship derives from the diminishing marginal productivity of capital. Economies will increase investment in capital as long as $MPK > r$. At the level of K/L for which $MPK = r$, capital deepening stops and labor productivity becomes stagnant.

However, as technological progress occurs, both capital and labor can produce a higher level of output. An investment in capital leading to technological progress enhances the productivity of existing labor and capital. Technological progress, therefore, can lead to continued increases in output despite diminishing marginal productivity of capital. Technological progress *shifts* the productivity curve upward and will lead to increased productivity at all levels of capital per worker.

labor productivity growth rate

= growth due to technological change + growth due to capital deepening

Figure 6.1: Productivity Curves

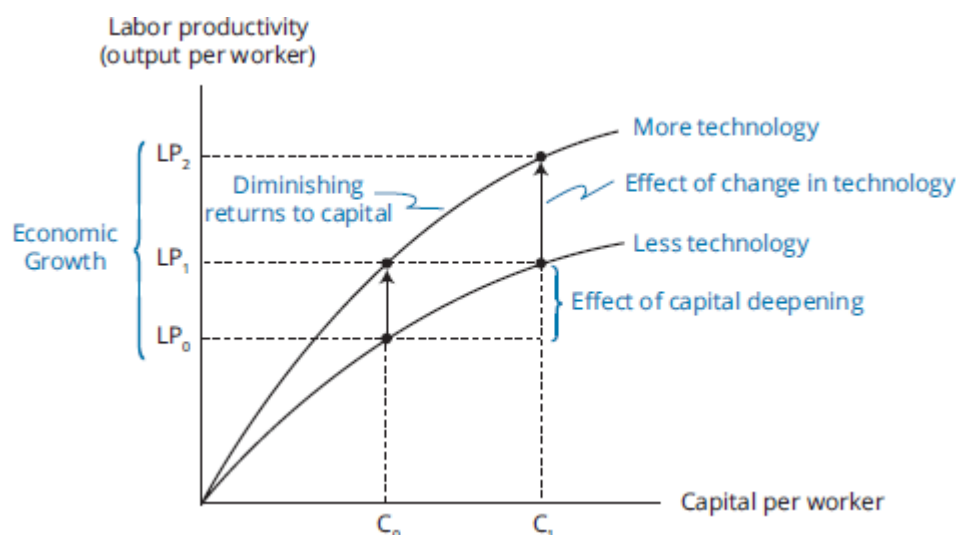

As stated earlier, for developed countries, the capital per worker ratio is relatively high (e.g., level C_1 in Figure 6.1), so those countries gain little from capital deepening and must rely on technological progress for growth in productivity. In contrast, developing nations often have low capital per worker ratios (e.g., C_0 in Figure 6.1), so capital deepening can lead to at least a short-term increase in productivity.

MODULE 6.2: GROWTH ACCOUNTING AND INFLUENCING FACTORS



Video covering this content is available online.

LOS 6.e: Demonstrate forecasting potential GDP based on growth accounting relations.

Growth Accounting Relations

Using the Cobb-Douglas production function, the growth in potential GDP can be expressed using the **growth accounting relation** as:

$$\Delta Y/Y = \Delta T/T + \alpha \times (\Delta K/K) + (1 - \alpha) \times (\Delta L/L)$$

where:

Y = output

T = technology

K = capital

L = labor

α = elasticity of output with respect to capital = share of income paid to capital

$(1 - \alpha)$ = elasticity of output with respect to labor = share of income paid to labor

or:

$$\begin{aligned} \text{growth rate in potential GDP} = & \text{long-term growth rate of technology} \\ & + \alpha (\text{long-term growth rate of capital}) \\ & + (1 - \alpha) (\text{long-term growth rate of labor}) \end{aligned}$$

In practice, levels of capital and labor are forecasted from their long-term trends, and the shares of capital and labor determined from national income accounts. The change in total factor productivity (technology) is not directly observable. Therefore, it must be estimated as a residual: the ex-post (realized) change in output minus the output implied by ex-post changes in labor and capital.

The growth accounting equation is also useful in determining the comparative effects of increasing different inputs. If labor growth accounts for the majority of economic growth, for example, analysts should be concerned with a country's ability to continue to increase its labor force. The relation can also be used to estimate potential output, as illustrated in the following example.

EXAMPLE: Estimating potential GDP growth rate

Azikland is an emerging market economy where labor cost accounts for 60% of total factor cost. The long-term trend of labor growth of 1.5% is expected to continue. Capital investment has been growing at 3%. The country has benefited greatly from borrowing the technology of more developed countries; total factor productivity is expected to increase by 2% annually. Compute the potential GDP growth rate for Azikland.

Answer:

Using the growth accounting equation:

$$\text{growth rate in potential GDP} = 2\% + (0.4)(3\%) + (0.6)(1.5\%) = 4.1\%$$

Another approach to forecasting potential GDP growth is the *labor productivity growth accounting equation*, which focuses on changes in labor as follows:

$$\text{growth rate in potential GDP} = \text{long-term growth rate of labor force} + \text{long-term growth rate in labor productivity}$$

The long-term growth rate in labor productivity reflects both capital deepening and technological progress.

LOS 6.f: Explain how natural resources affect economic growth and evaluate the argument that limited availability of natural resources constrains economic growth.

Natural resources include both renewable resources, such as timber, and non-renewable resources, such as oil and gas. The role of natural resources in economic growth is complex. In some instances, countries with abundant natural resources (e.g., Brazil) have grown rapidly. Yet other countries (e.g., some of the resource-rich countries of Africa) have not. Conversely, some resource-poor countries have managed impressive growth.

One reason that limited natural resources do not necessarily constrain economic growth is that *access* to natural resources does not require *ownership* of resources. Resource-poor countries may be able to access resources via trade. Japan, for example, has managed impressive growth and high per capita GDP despite having limited ownership of natural resources.

Other theories contend that ownership of natural resources may actually inhibit growth, because the economic energy of a country rich in natural resources may be focused on recovering those resources rather than developing other industries. Furthermore, countries that own valuable resources can find their currency appreciating as the demand for those resources increases. The so-called “Dutch disease” refers to a situation where global demand for a country’s natural resources drives up the country’s currency values, making all exports more expensive and rendering other domestic industries uncompetitive in the global markets.

LOS 6.g: Explain how demographics, immigration, and labor force participation affect the rate and sustainability of economic growth.

As stated previously, an increase in the quantity of labor will increase output, but not per capita output. Quantity of labor is defined as the size of the labor force multiplied by average hours worked. **Labor force** is defined as the number of working age (ages 16–64) people available to work, both employed and unemployed.

Labor Supply Factors

1. **Demographics.** A country’s demographics strongly influence its potential economic growth. As a country’s population ages and individuals live beyond working age, the labor force declines. Conversely, countries with younger populations have higher *potential* growth. Furthermore, fertility rates drive population growth and thereby affect potential future economic output. Countries with low or declining fertility rates will likely face growth challenges from labor force declines.
2. **Labor force participation.** Labor force participation is defined as the proportion of working age population in the labor force.

$$\text{labor force participation} = \frac{\text{labor force}}{\text{working age population}}$$

Labor force participation can increase as more women enter the workforce.

3. **Immigration.** Immigration poses a potential solution to a declining labor force. Countries with low population growth or adverse demographic shifts (older population) may find their growth constrained. Since developed countries tend to have lower fertility rates than less developed countries, immigration represents a potential source of continued economic growth in developed countries.
4. **Average hours worked.** For most countries, the general trend in average hours worked is downward. Possible explanations include legislation limiting the number of hours worked, the “wealth effect” which induces individuals to take more leisure time, high tax rates on labor income, and an increase in part-time and temporary workers.

EXAMPLE: Impact of demographics on economic growth

Data for Cangoria, a country in Asia, is shown here. Based upon this data, comment on the likely impact of Cangoria’s demographic changes on its economic growth. Assume average world population growth rate is 1.2% per year.

	Population	Labor Force Participation	Median Age of Population
2013	23,400,400	60.4%	39.2
2023	28,040,300	70.3%	38.1

Answer:

Cangoria's population grew at an average annual compound growth rate of approximately 1.8% per year over those 10 years. Combined with the increase in labor force participation, labor supply growth should be above average in the future for Cangoria if those trends continue. The young median age of the population also indicates an expected increase in the labor pool in the future.

Changes in per capita GDP are difficult to predict. Output is expected to be higher due an increasing labor pool, but the larger population may mean there is no impact on per capita GDP.

LOS 6.h: Explain how investment in physical capital, human capital, and technological development affects economic growth.

Human capital. Human capital is knowledge and skills individuals possess. Unlike quantitative labor metrics, such as hours worked, human capital is a qualitative measure of the labor force. Increasing human capital through education or work experience increases productivity and economic growth. Furthermore, human capital may have external spillover effects as knowledgeable workers innovate. Innovations are then used by society in general creating greater efficiencies economy wide.

Physical capital. Physical capital is generally separated into infrastructure, computers, and telecommunications capital (ICT) and non-ICT capital (i.e., machinery, transportation, and non-residential construction). Empirical research has found a strong positive correlation between investment in physical capital and GDP growth rates.

This result may seem inconsistent given our previous discussion about capital deepening and diminishing marginal returns to capital. Several explanations exist to explain why capital increases may still result in economic growth. First, many countries (e.g., developing economies) have relatively low capital to labor ratios, so increases in capital may still have significant impact on economic growth. Second, capital investment can take different forms. Some capital investment actually influences technological progress, thereby increasing TFP and economic growth. For example, acceleration of spending in the IT sector has created what are termed *network externalities*. Investment in IT networks may have multiplicative effects on productivity since IT network investment actually becomes more valuable as more people are connected to the network.

Technological development. Investment in technology includes investment in both physical and human capital. Technological innovation can manifest itself in processes, knowledge, information, machinery, and software, among other things. Researchers have examined proxies for investment in technology such as research and development (R&D) spending or

number of patents issued. Developed countries tend to spend the most on R&D since they rely on technological progress for growth given their high existing capital stock and slower population growth. In contrast, less developed countries often copy the technological innovations of developed countries and thus invest less in R&D as a percentage of GDP.

Ultimately, technological development should lead to increases in productivity as measured by GDP per worker. Developed countries tend to have very high levels of productivity by this measure while less developed countries tend to have greater potential for growth in productivity.

Public infrastructure. Investments in public infrastructure such as the construction of public roads, bridges, and municipal facilities, provide additional benefits to *private* investment. For example, an investment in distribution facilities by a private company would do little good without an interstate highway grid. The highway system, therefore, enhances total productivity for the economy by complementing the private investment and increasing total factor productivity.



MODULE QUIZ 6.1, 6.2

Use the following information to answer Questions 1 through 6.

Jay Smith, an analyst for Mako Capital, is evaluating investment prospects in Minikaz, an emerging market economy. Minikaz has experienced moderate growth in the past four years, after decades of stagnation. Smith is evaluating changes in government policies that would foster a higher level of growth. Figure 1 shows the summary of his findings.

Figure 1: Proposed Changes in Minikaz Government Policies

1. Consumer protection will be at the forefront of government's agenda.
2. The government will lower the entry barriers for foreign financial institutions to operate as intermediaries in Minikaz capital markets.
3. The government will expand public domain legislation to acquire private property for public works projects.

Smith reviews a report published by the Minikaz commerce department. The report indicates that the long-term real growth rate of Minikaz GDP is 2.5%, corporate profits as a percentage of GDP increased by 2% last year, and the P/E ratio increased from 17 to 19 over the last two years. Separately, Smith also reviews World Bank reports indicating that Minikaz's potential GDP growth is 4% and that it has been experiencing actual GDP growth of approximately 2.5%. Finally, Smith reviews Minikaz's national income accounts and finds that Minikaz is experiencing both technological progress and making increased capital expenditures.

Separately, Smith evaluates the performance of Kinimaz, a neighboring republic. Kinimaz has had labor growth of 2% over the last several years and capital growth of 3%. Labor's share of total output is estimated to be 60%. Over the same period, Kinimaz's real GDP has grown by 3.7%. Comparing the two countries, Smith notes that Kinimaz has substantially higher amounts of natural resource endowments. He concludes that Minikaz's relatively lower GDP growth is due to lack of natural resources.

1. Which of the following actions by Minikaz's government is most likely to increase Minikaz's economic growth rate?
 - A. Increasing protection for consumers through regulations.
 - B. Allowing foreign financial institutions to enter the market.

- C. Expanding public domain legislation.
2. Based on the commerce department report, what would be the *most likely* forecast for the long-term aggregate stock market appreciation?
 - A. 2.5%.
 - B. 4.5%.
 - C. 11.5%.
 3. Based on World Bank report, which of the following conclusions is *most likely* regarding Minikaz?
 - A. Inflation is 1.5%.
 - B. Minikaz's government is likely to follow a restrictive fiscal policy.
 - C. Minikaz's central bank is not likely to be worried about inflation.
 4. Using the Cobb-Douglas production function and the concepts of capital deepening and total factor productivity, which of the following outcomes is *most likely*?
 - A. Minikaz will experience an increase in sustainable growth of per capita output due to the increased capital expenditures.
 - B. There will be no short-term increase in per capita output.
 - C. There will be both short-term and long-term increases in Minikaz's GDP growth rate.
 5. Using the Cobb-Douglas relation, total factor productivity growth for Kinimaz is *closest* to:
 - A. 0.5%.
 - B. 1.3%.
 - C. 1.7%.
 6. Smith's conclusion about Minikaz's relatively lower GDP growth is *most likely*:
 - A. correct.
 - B. correct because in some cases, natural resources may inhibit economic growth.
 - C. incorrect because access to natural resources is more important than ownership.
 7. Data for the labor market of countries X and Y over the past year appears next:

Country	Unemployment Rate	% Population < Age 15	Avg. Hours Worked/Week	Immigration Growth
X	16%	16%	37	3.5%
Y	3%	10%	36.5	3.0%

Both countries are expected to have moderate economic expansions over the next several years. Which of the following statements is *most accurate* regarding labor input of the countries in the next several years?

- A. Country X will have greater opportunities to increase labor input.
 - B. Country Y will have greater opportunities to increase labor input.
 - C. Neither Country X nor Country Y will be able to increase labor input.
8. Which of the following would *least likely* have externality effects on output growth for an economy?
 - A. Human capital investment.
 - B. ICT investment.
 - C. Non-ICT investment.

MODULE 6.3: GROWTH AND CONVERGENCE THEORIES



Video covering this content is available online.

LOS 6.i: Compare classical growth theory, neoclassical growth theory, and

endogenous growth theory.

Theories of economic growth are largely separated into three models with differing views on the steady state growth potential of an economy.

Classical Growth Theory

Based on Malthusian economics, classical growth theory posits that, in the long-term, population growth increases whenever there are increases in per capita income above subsistence level due to an increase in capital or technological progress. Subsistence level is the minimum income needed to maintain life. Classical growth theory contends that growth in real GDP per capita is not permanent, because when real GDP per capita rises above the subsistence level, a population explosion occurs. Population growth leads to diminishing marginal returns to labor, which reduces productivity and drives GDP per capita back to the subsistence level. This mechanism would prevent long-term growth in per capita income. Classical growth theory is not supported by empirical evidence.

Neoclassical Growth Theory

Neoclassical growth theory's primary focus is on estimating the economy's long-term **steady state growth rate** (sustainable growth rate or equilibrium growth rate). The economy is at equilibrium when the output-to-capital ratio is constant. When the output-to-capital ratio is constant, the capital-to-labor ratio and output per capita also grow at the equilibrium growth rate, g^* . Under neoclassical theory, population growth is independent of economic growth.



PROFESSOR'S NOTE

Steady state growth rate for the purpose of neoclassical growth theory does not assume a constant level of technology and hence differs from the definition of steady state discussed earlier.

Based on the Cobb-Douglas function discussed earlier, neoclassical growth theory states that:

- Sustainable growth of output per capita (or output per worker)(g^*) is equal to the growth rate in technology (θ) divided by labor's share of GDP ($1 - \alpha$).

$$g^* = \frac{\theta}{(1 - \alpha)}$$

- Sustainable growth rate of output (G^*) is equal to the sustainable growth rate of output per capita, plus the growth of labor (ΔL).

$$G^* = \frac{\theta}{(1 - \alpha)} + \Delta L$$



PROFESSOR'S NOTE

In the equations for sustainable growth (per capita or total), growth rate is not affected by capital (K). Hence, we say that capital deepening is occurring but it does not affect growth rate once steady state is achieved.

EXAMPLE: Estimating steady state growth rate

An analyst is forecasting steady state growth rates for Country X and Country Y and has collected the following estimates:

Country	TFP Growth Rate	Labor Force Growth Rate	Labor Cost as a Proportion of Total Factor Cost
X	2.0%	1.2%	0.60
Y	1.0%	2.6%	0.52

Calculate and comment on sustainable growth rates for the two countries.

Answer:

Sustainable growth rates:

$$\text{Country X} = (2.0\% / 0.60) + 1.2\% = 4.53\%$$

$$\text{Country Y} = (1.0\% / 0.52) + 2.6\% = 4.52\%$$

Thus, the sustainable growth rates for the two countries are comparable. Country X's sustainable growth rate is primarily driven by higher growth rate in TFP. Country Y's sustainable growth rate is mostly driven by a higher population growth rate.

Under neoclassical theory:

- Capital deepening affects the *level* of output but not the *growth rate* in the long run. Capital deepening may temporarily increase the growth rate, but the growth rate will revert back to the sustainable level if there is no technological progress.
- An economy's growth rate will move towards its steady state regardless of the *initial* capital to labor ratio or level of technology.
- In the steady state, the growth rate in productivity (i.e., output per worker) is a function only of the growth rate of technology (θ) and labor's share of total output ($1 - \alpha$).
- In the steady state, marginal product of capital (MPK) = $\alpha Y/K$ is constant, but marginal productivity is diminishing.
- An increase in savings will only temporarily raise economic growth. However, countries with higher savings rates will enjoy higher capital to labor ratio and higher productivity.
- Developing countries (with a lower level of capital per worker) will be impacted less by diminishing marginal productivity of capital, and hence have higher growth rates as compared to developed countries; there will be eventual convergence of growth rates.

Endogenous Growth Theory

In contrast to the neoclassical model, **endogenous growth theory** contends that technological growth emerges as a *result* of investment in both physical and human capital (hence the name *endogenous* which means coming from within). Technological progress

enhances productivity of both labor and capital. Unlike the neoclassical model, there is no steady state growth rate, so that increased investment can permanently increase the rate of growth.

The driving force behind the endogenous growth theory result is the assumption that certain investments increase TFP (i.e., lead to technological progress) from a societal standpoint. Increasing R&D investments, for example, results in benefits that are also external to the firm making the R&D investments. Those benefits raise the level of growth for the entire economy.

The endogenous growth model theorizes that returns to *capital* are constant. The key implication of constant returns to capital is the effect of an increase in savings: unlike the neoclassical model, the endogenous growth model implies that an increase in savings will permanently increase the growth rate.

The difference between neoclassical and endogenous growth theory relates to total factor productivity. Neoclassical theory assumes that capital investment will expand as technology improves (i.e., growth comes from increases in TFP not related to the investment in capital within the model). Endogenous growth theory, on the other hand, assumes that capital investment (R&D expenditures) may actually improve total factor productivity.

LOS 6.j: Explain and evaluate convergence hypotheses.

Empirical evidence indicates that there are large differences between productivity (output per capita) of different countries, with less developed countries experiencing much lower output per capita than their developed counterparts. The economic question is whether productivity, and hence, living standards tend to converge over time. Will less developed countries experience productivity growth to match the productivity of developed nations?

The **absolute convergence** hypothesis states that less-developed countries will converge to the level of per capita output of more-developed countries. The neoclassical model assumes that every country has access to the same technology. This leads to countries having the same *growth rates* but not the same per capita income and as such, the neoclassical model does not imply absolute convergence. The neoclassical model supports the **conditional convergence** hypothesis, which states that the convergence in living standards will only occur for countries with the same savings rates, population growth rates, and production functions. Under the conditional convergence hypothesis, the growth rate will be higher for less developed countries until they catch up and achieve a similar standard of living. Under the neoclassical model, once a developing country's standard of living converges with that of developed countries, the growth rate will then stabilize to the same steady state growth rate as that of developed countries.

An additional hypothesis is **club convergence**. Under this hypothesis, countries may be part of a "club" (i.e., countries with similar institutional features such as savings rates, financial markets, property rights, health and educational services, etc.). Under club convergence, poorer countries that are part of the club will grow rapidly to catch up with their richer peers. Countries can "join" the club by making appropriate institutional changes. Those countries that are not part of the club may never achieve the higher standard of living.

Empirical evidence shows that developing economies often (but not always) reach the standard of living of more developed ones. Over the past half century, about two-thirds of economies with a lower standard of living than the United States grew at a faster pace than the United States. Though they have not converged to standard of living of the United States, their more rapid growth provides at least some support for the convergence hypothesis. The club convergence theory may explain why some countries that have not implemented appropriate economic or political reforms still lag behind.

LOS 6.k: Describe the economic rationale for governments to provide incentives to private investment in technology and knowledge.

Firms accept projects when they provide an expected return greater than their risk-adjusted cost of capital. Under endogenous growth theory, private sector investments in R&D and knowledge capital benefit the society overall. For example, a new technology may initially benefit the firm that developed it but may also boost the country's overall productivity. The effects of "social returns" or externalities are captured in the endogenous growth theory model, which concludes that economies may not reach a steady state growth but may permanently increase growth by expenditures that provide both benefits to the company (private benefits) and benefits to society (externalities).

When the external benefits to the economy (the social returns) of investing in R&D are not considered, many possible R&D projects do not have expected returns (private benefits) high enough to compensate firms for the inherent riskiness of R&D investments. From an aggregate, economy-wide viewpoint, the resultant level of R&D investment will be sub-optimal or too low. Government incentives that effectively subsidize R&D investments can theoretically increase private spending on R&D investments to its optimal level.

LOS 6.l: Describe the expected impact of removing trade barriers on capital investment and profits, employment and wages, and growth in the economies involved.

None of the growth theories that we have discussed account for potential trade and capital flows between countries. Removing trade barriers and allowing for free flow of capital is likely to have the following benefits for countries:

- Increased investment from foreign savings.
- Allows focus on industries where the country has a comparative advantage.
- Increased markets for domestic products, resulting in economies of scale.
- Increased sharing of technology and higher total factor productivity growth.
- Increased competition leading to failure of inefficient firms and reallocation of their assets to more efficient uses.

The neoclassical model's predictions in an open economy (i.e., an economy without any barriers to trade or capital flow) focus on the convergence. Since developing economies have not reached the point of significant diminishing returns on capital, they can attract capital through foreign investment and experience productivity growth as a result. Eventually, these economies will develop; their growth will slow and will converge to the steady state growth rate of developed economies.

The endogenous growth model also predicts greater growth with free trade and high mobility of capital since open markets foster increased innovation. As foreign competition increases, more efficient and innovative firms will survive. Those firms permanently increase the growth rate of the international economy by providing benefits beyond those simply captured by the firm. Economies of scale also increase output as firms serve larger markets and become more efficient.

In terms of convergence, removing barriers on capital and trade flows may speed the convergence of standard of living of less developed countries to that of developed countries. Research has shown that as long as countries follow outward-oriented policies of integrating their industries with the world economy and increasing exports, their standard of living tends to converge to that of more developed countries. Countries following inward-oriented policies and protecting domestic industries, can expect slower GDP growth and convergence may not occur.



MODULE QUIZ 6.3

1. Country X has output elasticity of capital of 0.6 and population growth of 2%. If total factor productivity growth is 1%, what is the sustainable growth rate in output according to neoclassical theory?
 - A. 2.0%.
 - B. 2.7%.
 - C. 4.5%.
2. Which of the following is the *most accurate* description of club convergence?
 - A. Less developed countries will converge to living standards of other less developed countries.
 - B. More developed countries may see their standard of living drop due to competition from less developed countries.
 - C. Some less developed countries may converge to developed country living standards while others may not.
3. A chief economist argues that government policy should include an additional tax break for research and development expenses. The economist *most likely* agrees with:
 - A. endogenous growth theory.
 - B. neoclassical theory.
 - C. classical theory.

Use the following information to answer Questions 4 through 5.

Jignesh Sangani, an economist with a large asset management firm, makes the following statements about removal of barriers to trade and capital flows:

Statement 1: Removal of barriers is likely to lead to permanently higher global economic growth under the neoclassical theory.

Statement 2: Removal of barriers is likely to lead to permanently higher economic growth for developing countries only under the endogenous growth theory.

4. Sangani's Statement 1 is *most likely*:
 - A. correct.
 - B. incorrect due to economic growth being permanent.
 - C. incorrect due to economic growth being global.
5. Sangani's Statement 2 is *most likely*:
 - A. correct.

- B. incorrect due to economic growth being permanent.
C. incorrect due to economic growth being limited to developing countries only.
6. Which of the following is *least likely* to be associated with the law of diminishing returns?
A. Investment in labor.
B. Investment in knowledge capital.
C. Investment in physical capital.

KEY CONCEPTS

LOS 6.a

Significant differences in growth rates exist between economies. The following factors are positively related to growth rate:

- Sufficient level of savings and investment.
- Development of financial markets and financial intermediaries.
- Political stability, sound laws, and property rights.
- Investment in education and health care systems.
- Lower taxes and regulatory burdens.
- Free trade and unrestricted capital flows.

LOS 6.b

In the long-run, the rate of aggregate stock market appreciation is limited to the sustainable growth rate of the economy.

LOS 6.c

Potential GDP represents the maximum output of an economy without putting upward pressure on prices. Higher potential GDP growth increases the potential for stock returns but also increases the credit quality of all fixed-income investments, all else equal.

In the short term, the difference between potential GDP and actual GDP may be useful for predicting fiscal and monetary policy. If actual GDP is less than potential GDP, inflation is unlikely and the government may follow an expansionary monetary/fiscal policy.

LOS 6.d

Capital deepening is an increase in the capital stock and the capital to labor ratio. Due to diminishing marginal productivity of capital, capital deepening will lead to only limited increases in output and labor productivity if the capital to labor ratio is already high.

Technological progress enhances the productivity of both labor and capital but not the relative productivity of either. The long-term growth rate can be increased by technological progress (also called total factor productivity) since output and labor efficiency are increased at all levels of capital to labor ratios. TFP is a scale factor. It however does not alter the productivity function (alpha value).

LOS 6.e

$$\begin{aligned}\text{growth rate in potential GDP} &= \text{long-term growth rate of technology} \\ &+ \alpha (\text{long-term growth rate in capital}) \\ &+ (1 - \alpha) (\text{long-term growth rate in labor})\end{aligned}$$

or

$$\begin{aligned}\text{growth rate in potential GDP} &= \text{long-term growth rate of labor force} \\ &+ \text{long-term growth rate in labor productivity}\end{aligned}$$

LOS 6.f

Natural resources are essential to economic growth. Empirical evidence has shown, however, that *ownership* of natural resources is not necessary for growth. As long as nations can acquire natural resources through trade, they can experience substantial growth. In some cases, ownership of natural resources may even inhibit growth since countries with abundant natural resources may not develop other industries.

LOS 6.g

Quantity of labor is a function of population growth, workforce participation, immigration, and average hours worked. All else equal, countries with higher population growth, higher workforce participation, younger working-age populations, higher average hours worked, and higher net immigration can grow faster due to higher labor input.

LOS 6.h

The economic growth rate of a country is positively correlated with investments in both physical and human capital. Furthermore, technological development (as evidenced by spending on R&D) is critical for economic growth. This is especially true for developed countries that already have large capital stock and a slower population growth rate.

LOS 6.i

Classical growth theory states that growth in real GDP per capita is temporary—when the GDP per capita rises above the subsistence level, a population explosion occurs, and GDP per capita is driven back to the subsistence level.

Neoclassical growth theory states that the sustainable growth rate of GDP is a function of population growth, labor's share of income, and the rate of technological advancement. Growth gains from other means such as increased savings are only temporary.

Endogenous growth theory includes the impact of technological progress within the model. Under endogenous growth theory, investment in capital can have constant returns, unlike neoclassical theory that assumes diminishing returns to capital. This assumption allows for a permanent increase in growth rate attributable to an increase in savings rate. Research and development expenditures are often cited as examples of capital investment that increase technological progress.

LOS 6.j

Absolute convergence states that the per capita growth *rates* (not growth *level*) will converge (i.e., be the same across all countries). The conditional convergence hypothesis assumes that convergence in living standards (i.e., *level* of per capita output) will only

occur for countries with the same savings rate, population growth, and production functions.

The club convergence hypothesis contends that living standards in some less developed countries may converge to living standards of developed standards if they are in the same “club.” A club comprises countries with similar institutional structures (such as property rights and political stability). Countries outside of the club (without the appropriate institutional structures) will not see their living standards converge.

LOS 6.k

Under the endogenous growth theory, investments in R&D, though risky, often enhance the productivity of the entire economy. Since the private investor only reaps part of the benefit of those investments, it is likely that private sector investments in R&D will be less than what would be optimal for the economy. Government subsidies can make these investments more attractive to private businesses.

LOS 6.l

Economies grow faster in an environment of no trade barriers and free capital flows. Higher growth rates are possible because foreign investment can provide capital to less developed countries (neoclassical theory). The larger markets and greater opportunity to take advantage of innovation will also increase the growth rate in open economies (endogenous growth theory).

Finally, convergence of living standards is likely to be quicker in an open economy.

ANSWER KEY FOR MODULE QUIZZES

Module Quiz 6.1, 6.2

1. **B** Financial intermediary development helps foster economic growth by allowing more efficient allocation of capital and risk. (Module 6.1, LOS 6.a)
2. **A** Long-term growth in the stock market is a function of GDP growth. The other factors —profits as a percentage of GDP and P/E ratios—will have a long-term growth rate of approximately zero and will not impact a forecast of long-term growth in the stock market. (Module 6.1, LOS 6.a)
3. **C** Potential GDP can be interpreted as the highest growth that can be obtained without pressure on prices. Since actual GDP is lower than potential, there is little risk of inflation. (Module 6.1, LOS 6.b)
4. **C** Since Minikaz is a developing country, it is likely to have a low capital base. With a low capital base, increased capital expenditures will still have an impact on output per worker. Technological progress always has a positive impact on output per worker. (Module 6.1, LOS 6.d)

5. **B** Use the growth accounting relations and solving for growth in TFP.

$$3.7\% = \Delta TFP + 0.4(3\%) + 0.6(2\%)$$

$$\Delta TFP = 1.3\%$$

(Module 6.2, LOS 6.e)

6. **C** Empirical evidence has shown that for economic growth, access to natural resources is more important than ownership. Natural resources may inhibit growth if countries that own them do not develop other industries. However, that is not the conclusion Smith reaches. (Module 6.2, LOS 6.f)

7. **A** Country X will have the greater opportunity due to the younger workforce, potential labor input from unemployed workers, and immigration. (Module 6.2, LOS 6.g)

8. **C** Both human capital and ICT investment tend to have societal benefits. This spillover effect enhances overall growth rate. (Module 6.2, LOS 6.h)

Module Quiz 6.3

1. **C** Using the equation from neoclassical theory, $1\% / (1 - 0.6) + 2\% = 4.5\%$. (LOS 6.i)

2. **C** The notion of the club is that some nations are not in the club and will not converge. (LOS 6.j)

3. **A** Endogenous growth theory includes the concept that R&D may have external benefits, and, therefore, should be subsidized by the government. (LOS 6.i)

4. **B** Under the neoclassical growth theory, the benefit of open markets is temporary. (LOS 6.i)

5. **C** Under the endogenous growth theory, open markets lead to higher rate of growth permanently for all markets. (LOS 6.i)

6. **B** Knowledge capital is a special type of public good that is not subject to the law of diminishing returns. Investment in labor and physical capital do exhibit diminishing returns, which are reflected in the shape of the productivity curve. (LOS 6.k)

Topic Quiz: Economics

You have now finished the Economics topic section. Please log into your Schweser online dashboard and take the Topic Quiz on this section. The Topic Quiz provides immediate feedback on how effective your study has been for this material. Questions are more exam-like than typical Module Quiz or QBank questions; a score of less than 70% indicates that your study likely needs improvement. These tests are best taken timed; allow three minutes per question.

FORMULAS

Quantitative Methods

Multiple Regression

Coefficient of Determination, R^2

$$R^2 = \frac{\text{total variation} - \text{unexplained variation}}{\text{total variation}} = \frac{\text{SST} - \text{SSE}}{\text{SST}}$$
$$= \frac{\text{explained variation}}{\text{total variation}} = \frac{\text{RSS}}{\text{SST}}$$

$$\text{MSE} = \frac{\text{SSE}}{n - k - 1}; \text{MSR} = \frac{\text{RSS}}{k}; R^2 = \frac{\text{RSS}}{\text{SST}}$$

Adjusted R^2

$$R_a^2 = 1 - \left[\left(\frac{n-1}{n-k-1} \right) \times (1 - R^2) \right]$$

Akaike's information criterion (AIC):

$$\text{AIC} = n \times \ln\left(\frac{\text{SSE}}{n}\right) + 2(k + 1)$$

Schwarz's Bayesian information criteria (BIC):

$$\text{BIC} = n \times \ln\left(\frac{\text{SSE}}{n}\right) + \ln(n) \times (k + 1)$$

F-statistic to evaluate nested models:

$$F = \frac{(\text{SSE}_R - \text{SSE}_U)/q}{(\text{SSE}_U)/(n - k - 1)} \text{ with } q \text{ and } (n - k - 1) \text{ degrees of freedom.}$$

F-test statistic to evaluate overall model fit:

$$F = \frac{(\text{SSE}_R - \text{SSE}_U)/q}{(\text{SSE}_U)/(n - k - 1)} = \frac{(\text{SST}_U - \text{SSE}_U)/k}{(\text{SSE}_U)/(n - k - 1)} = \frac{(\text{RSS}_U)/k}{(\text{SSE}_U)/(n - k - 1)}$$

Logistic regression (logit) models

$$\ln\left(\frac{p}{1-p}\right) = b_0 + b_1X_1 + b_2X_2 + \dots + \varepsilon$$

$$\text{odds} = e^{\hat{y}}$$

$$P = \text{odds} / (1 + \text{odds}) = 1 / (1 + e^{-\hat{y}})$$

Likelihood ratio (LR) test for logistic regressions:

$$LR = -2 (\log \text{likelihood restricted model} - \log \text{likelihood unrestricted model})$$

Time-Series Analysis

AR model of order p , $AR(p)$: $x_t = b_0 + b_1 x_{t-1} + b_2 x_{t-2} + \dots + b_p x_{t-p} + \varepsilon_t$

Mean reverting level of $AR(1)$: $x_t = \frac{b_0}{(1 - b_1)}$

ARCH(1) model: $\hat{\varepsilon}_t^2 = a_0 + a_1 \hat{\varepsilon}_{t-1}^2 + \mu_t$

Big Data Projects

$$\text{normalized } X_i = \frac{X_i - X_{\min}}{X_{\max} - X_{\min}}$$

$$\text{standardized } X_i = \frac{X_i - \mu}{\sigma}$$

$$\text{accuracy} = (TP + TN) / (TP + TN + FP + FN)$$

$$F1 \text{ score} = (2 \times P \times R) / (P + R)$$

$$\text{true positive rate (TPR)} = TP / (TP + FN)$$

$$\text{false positive rate (FPR)} = FP / (FP + TN)$$

$$RMSE = \sqrt{\frac{\sum_{i=1}^n (\text{predicted}_i - \text{actual}_i)^2}{n}}$$

Economics

Where applicable, ALL notation assumes A/B currency quote convention.

bid-ask spread (for base currency) = ask quote - bid quote

cross rates with bid-ask spreads:

$$\left(\frac{A}{C}\right)_{\text{bid}} = \left(\frac{A}{B}\right)_{\text{bid}} \times \left(\frac{B}{C}\right)_{\text{bid}} \quad \left(\frac{A}{C}\right)_{\text{offer}} = \left(\frac{A}{B}\right)_{\text{offer}} \times \left(\frac{B}{C}\right)_{\text{offer}}$$

forward premium = (forward price) - (spot price) = $F - S_0$

value of a forward currency contract prior to expiration:

$$V_t = \frac{(FP_t - FP)(\text{contract size})}{\left[1 + R\left(\frac{\text{days}}{360}\right)\right]}$$

covered interest rate parity:

$$F = \frac{\left[1 + R_A \left(\frac{\text{days}}{360}\right)\right]}{\left[1 + R_B \left(\frac{\text{days}}{360}\right)\right]} S_0$$

uncovered interest rate parity:

$$E(\% \Delta S)_{(A/B)} = R_A - R_B$$

Fisher relation:

$$R_{\text{nominal}} = R_{\text{real}} + E(\text{inflation})$$

international Fisher relation:

$$R_{\text{nominal A}} - R_{\text{nominal B}} = E(\text{inflation}_A) - E(\text{inflation}_B)$$

relative purchasing power parity:

$$\% \Delta S_{(A/B)} = \text{inflation}_{(A)} - \text{inflation}_{(B)}$$

where:

$$\% \Delta S_{(A/B)} = \text{change in spot price (A/B)}$$

labor productivity:

$$\text{output per worker} = Y/L = T(K/L)^\alpha$$

growth accounting relation:

$$\begin{aligned} \text{growth rate in potential GDP} &= \text{long-term growth rate of technology} \\ &+ \alpha(\text{long-term growth rate of capital}) \\ &+ (1 - \alpha)(\text{long-term growth rate of labor}) \end{aligned}$$

or

$$\begin{aligned} \text{growth rate in potential GDP} &= \text{long-term growth rate of labor force} \\ &+ \text{long-term growth rate in labor productivity} \end{aligned}$$

neoclassical growth theory:

sustainable growth of output per capita (g^*) equals growth rate in technology (θ) divided by labor's share of GDP ($1 - \alpha$)

$$g^* = \frac{\theta}{(1 - \alpha)}$$

sustainable growth rate of output (G^*) equals sustainable growth rate of output per capita plus growth of labor (ΔL)

$$G^* = \frac{\theta}{(1 - \alpha)} + \Delta L$$

APPENDIX A: STUDENT'S T-DISTRIBUTION

Level of Significance for One-Tailed Test						
df	0.100	0.050	0.025	0.01	0.005	0.0005

Level of Significance for Two-Tailed Test						
df	0.20	0.10	0.05	0.02	0.01	0.001
1	3.078	6.314	12.706	31.821	63.657	636.619
2	1.886	2.920	4.303	6.965	9.925	31.599
3	1.638	2.353	3.182	4.541	5.841	12.294
4	1.533	2.132	2.776	3.747	4.604	8.610
5	1.476	2.015	2.571	3.365	4.032	6.869
6	1.440	1.943	2.447	3.143	3.707	5.959
7	1.415	1.895	2.365	2.998	3.499	5.408
8	1.397	1.860	2.306	2.896	3.355	5.041
9	1.383	1.833	2.262	2.821	3.250	4.781
10	1.372	1.812	2.228	2.764	3.169	4.587
11	1.363	1.796	2.201	2.718	3.106	4.437
12	1.356	1.782	2.179	2.681	3.055	4.318
13	1.350	1.771	2.160	2.650	3.012	4.221
14	1.345	1.761	2.145	2.624	2.977	4.140
15	1.341	1.753	2.131	2.602	2.947	4.073
16	1.337	1.746	2.120	2.583	2.921	4.015
17	1.333	1.740	2.110	2.567	2.898	3.965
18	1.330	1.734	2.101	2.552	2.878	3.922
19	1.328	1.729	2.093	2.539	2.861	3.883
20	1.325	1.725	2.086	2.528	2.845	3.850
21	1.323	1.721	2.080	2.518	2.831	3.819
22	1.321	1.717	2.074	2.508	2.819	3.792
23	1.319	1.714	2.069	2.500	2.807	3.768
24	1.318	1.711	2.064	2.492	2.797	3.745
25	1.316	1.708	2.060	2.485	2.787	3.725
26	1.315	1.706	2.056	2.479	2.779	3.707
27	1.314	1.703	2.052	2.473	2.771	3.690
28	1.313	1.701	2.048	2.467	2.763	3.674
29	1.311	1.699	2.045	2.462	2.756	3.659
30	1.310	1.697	2.042	2.457	2.750	3.646
40	1.303	1.684	2.021	2.423	2.704	3.551
60	1.296	1.671	2.000	2.390	2.660	3.460
120	1.289	1.658	1.980	2.358	2.617	3.373
∞	1.282	1.645	1.960	2.326	2.576	3.291

APPENDIX B: F-TABLE AT 5% (UPPER TAIL)

Degrees of freedom for the numerator along top row

Degrees of freedom for the denominator along side row

	1	2	3	4	5	6	7	8	9	10	12	15	20	24	30	40
1	161	200	216	225	230	234	237	239	241	242	244	246	248	249	250	251
2	18.5	19.0	19.2	19.2	19.3	19.3	19.4	19.4	19.4	19.4	19.4	19.4	19.4	19.5	19.5	19.5
3	10.1	9.55	9.28	9.12	9.01	8.94	8.89	8.85	8.81	8.79	8.74	8.70	8.66	8.64	8.62	8.59
4	7.71	6.94	6.59	6.39	6.26	6.16	6.09	6.04	6.00	5.96	5.91	5.86	5.80	5.77	5.75	5.72
5	6.61	5.79	5.41	5.19	5.05	4.95	4.88	4.82	4.77	4.74	4.68	4.62	4.56	4.53	4.50	4.46
6	5.99	5.14	4.76	4.53	4.39	4.28	4.21	4.15	4.10	4.06	4.00	3.94	3.87	3.84	3.81	3.77
7	5.59	4.74	4.35	4.12	3.97	3.87	3.79	3.73	3.68	3.64	3.57	3.51	3.44	3.41	3.38	3.34
8	5.32	4.46	4.07	3.84	3.69	3.58	3.50	3.44	3.39	3.35	3.28	3.22	3.15	3.12	3.08	3.04
9	5.12	4.26	3.86	3.63	3.48	3.37	3.29	3.23	3.18	3.14	3.07	3.01	2.94	2.90	2.86	2.83
10	4.96	4.10	3.71	3.48	3.33	3.22	3.14	3.07	3.02	2.98	2.91	2.85	2.77	2.74	2.70	2.66
11	4.84	3.98	3.59	3.36	3.20	3.09	3.01	2.95	2.90	2.85	2.79	2.72	2.65	2.61	2.57	2.53
12	4.75	3.89	3.49	3.26	3.11	3.00	2.91	2.85	2.80	2.75	2.69	2.62	2.54	2.51	2.47	2.43
13	4.67	3.81	3.41	3.18	3.03	2.92	2.83	2.77	2.71	2.67	2.60	2.53	2.46	2.42	2.38	2.34
14	4.60	3.74	3.34	3.11	2.96	2.85	2.76	2.70	2.65	2.60	2.53	2.46	2.39	2.35	2.31	2.27
15	4.54	3.68	3.29	3.06	2.90	2.79	2.71	2.64	2.59	2.54	2.48	2.40	2.33	2.29	2.25	2.20
16	4.49	3.63	3.24	3.01	2.85	2.74	2.66	2.59	2.54	2.49	2.42	2.35	2.28	2.24	2.19	2.15
17	4.45	3.59	3.20	2.96	2.81	2.70	2.61	2.55	2.49	2.45	2.38	2.31	2.23	2.19	2.15	2.10
18	4.41	3.55	3.16	2.93	2.77	2.66	2.58	2.51	2.46	2.41	2.34	2.27	2.19	2.15	2.11	2.06
19	4.38	3.52	3.13	2.90	2.74	2.63	2.54	2.48	2.42	2.38	2.31	2.23	2.16	2.11	2.07	2.03
20	4.35	3.49	3.10	2.87	2.71	2.60	2.51	2.45	2.39	2.35	2.28	2.20	2.12	2.08	2.04	1.99
21	4.32	3.47	3.07	2.84	2.68	2.57	2.49	2.42	2.37	2.32	2.25	2.18	2.10	2.05	2.01	1.96
22	4.30	3.44	3.05	2.82	2.66	2.55	2.46	2.40	2.34	2.30	2.23	2.15	2.07	2.03	1.98	1.94
23	4.28	3.42	3.03	2.80	2.64	2.53	2.44	2.37	2.32	2.27	2.20	2.13	2.05	2.01	1.96	1.91
24	4.26	3.40	3.01	2.78	2.62	2.51	2.42	2.36	2.30	2.25	2.18	2.11	2.03	1.98	1.94	1.89
25	4.24	3.39	2.99	2.76	2.60	2.49	2.40	2.34	2.28	2.24	2.16	2.09	2.01	1.96	1.92	1.87
30	4.17	3.32	2.92	2.69	2.53	2.42	2.33	2.27	2.21	2.16	2.09	2.01	1.93	1.89	1.84	1.79
40	4.08	3.23	2.84	2.61	2.45	2.34	2.25	2.18	2.12	2.08	2.00	1.92	1.84	1.79	1.74	1.69
60	4.00	3.15	2.76	2.53	2.37	2.25	2.17	2.10	2.04	1.99	1.92	1.84	1.75	1.70	1.65	1.59
120	3.92	3.07	2.68	2.45	2.29	2.18	2.09	2.02	1.96	1.91	1.83	1.75	1.66	1.61	1.55	1.50
∞	3.84	3.00	2.60	2.37	2.21	2.10	2.01	1.94	1.88	1.83	1.75	1.67	1.57	1.52	1.46	1.39

APPENDIX C: CHI-SQUARED TABLE

Values of χ^2 (Degrees of Freedom, Level of Significance)

Probability in Right Tail

Degrees of Freedom	0.99	0.975	0.95	0.9	0.1	0.05	0.025	0.01	0.005
1	0.000157	0.000982	0.003932	0.0158	2.706	3.841	5.024	6.635	7.879
2	0.020100	0.050636	0.102586	0.2107	4.605	5.991	7.378	9.210	10.597
3	0.1148	0.2158	0.3518	0.5844	6.251	7.815	9.348	11.345	12.838
4	0.297	0.484	0.711	1.064	7.779	9.488	11.143	13.277	14.860
5	0.554	0.831	1.145	1.610	9.236	11.070	12.832	15.086	16.750
6	0.872	1.237	1.635	2.204	10.645	12.592	14.449	16.812	18.548
7	1.239	1.690	2.167	2.833	12.017	14.067	16.013	18.475	20.278
8	1.647	2.180	2.733	3.490	13.362	15.507	17.535	20.090	21.955
9	2.088	2.700	3.325	4.168	14.684	16.919	19.023	21.666	23.589
10	2.558	3.247	3.940	4.865	15.987	18.307	20.483	23.209	25.188
11	3.053	3.816	4.575	5.578	17.275	19.675	21.920	24.725	26.757
12	3.571	4.404	5.226	6.304	18.549	21.026	23.337	26.217	28.300
13	4.107	5.009	5.892	7.041	19.812	22.362	24.736	27.688	29.819
14	4.660	5.629	6.571	7.790	21.064	23.685	26.119	29.141	31.319
15	5.229	6.262	7.261	8.547	22.307	24.996	27.488	30.578	32.801
16	5.812	6.908	7.962	9.312	23.542	26.296	28.845	32.000	34.267
17	6.408	7.564	8.672	10.085	24.769	27.587	30.191	33.409	35.718
18	7.015	8.231	9.390	10.865	25.989	28.869	31.526	34.805	37.156
19	7.633	8.907	10.117	11.651	27.204	30.144	32.852	36.191	38.582
20	8.260	9.591	10.851	12.443	28.412	31.410	34.170	37.566	39.997
21	8.897	10.283	11.591	13.240	29.615	32.671	35.479	38.932	41.401
22	9.542	10.982	12.338	14.041	30.813	33.924	36.781	40.289	42.796
23	10.196	11.689	13.091	14.848	32.007	35.172	38.076	41.638	44.181
24	10.856	12.401	13.848	15.659	33.196	36.415	39.364	42.980	45.558
25	11.524	13.120	14.611	16.473	34.382	37.652	40.646	44.314	46.928
26	12.198	13.844	15.379	17.292	35.563	38.885	41.923	45.642	48.290
27	12.878	14.573	16.151	18.114	36.741	40.113	43.195	46.963	49.645
28	13.565	15.308	16.928	18.939	37.916	41.337	44.461	48.278	50.994
29	14.256	16.047	17.708	19.768	39.087	42.557	45.722	49.588	52.335
30	14.953	16.791	18.493	20.599	40.256	43.773	46.979	50.892	53.672
50	29.707	32.357	34.764	37.689	63.167	67.505	71.420	76.154	79.490
60	37.485	40.482	43.188	46.459	74.397	79.082	83.298	88.379	91.952
80	53.540	57.153	60.391	64.278	96.578	101.879	106.629	112.329	116.321
100	70.065	74.222	77.929	82.358	118.498	124.342	129.561	135.807	140.170

INDEX

A

absolute convergence, 167
absolute purchasing power parity, 128
accuracy, 104
activation function, 85
adjusted R^2 , 8
agglomerative clustering, 84
analysis of variance, 7
application programming interface (API), 95
ARCH model, 63
autocorrelation, 19
autoregressive conditional heteroskedasticity (ARCH), 63
autoregressive models (AR), 48
average hours worked, 160

B

backward propagation, 85
bagging, 82
bag-of-words (BOW), 97
balance-of-payments, 134
base error, 78
bias error, 78, 106
bid-ask spread, 115, 118
bid-offer spread, 115
big data, 93
bootstrap aggregating, 82
Breusch–Godfrey (BG) test, 20
Breusch–Pagan (BP), 18

C

capital account, 134
capital controls, 135
capital deepening, 157
carry trade, 132
ceiling analysis, 107
centroid, 84
chain rule of forecasting, 48
chi-square, 100
chi square test, 17
classical growth theory, 164
classification and regression trees (CART), 81
class imbalance, 103
club convergence, 167
clustering, 84
Cobb-Douglas production function, 156
coefficient of determination, 8
cointegration, 65
conditional convergence, 167
conditional heteroskedasticity, 16
confusion matrix, 104
constant returns to scale, 156
convergence hypotheses, 167
co-occurrence, 99
covariance stationary, 47, 65
covered interest rate parity, 124
crash risk, 133
cross rate, 117
cross validation, 79
currency crisis, 139
current account, 134

D

data cleansing, 95
data wrangling, 95
debt sustainability mechanism, 135
deep learning, 76
degree of freedom, 18
demographics, 160
dependent variable, 12

- predicting, 12
- DF–EG test, 65
- Dickey and Fuller (DF), 55, 65
- Dickey Fuller, 65
- divisive clustering, 85
- document frequency (DF), 100
- document term matrix, 97
- Dornbusch overshooting model, 137
- dummy variables, 25, 27
- Durbin–Watson (DW) statistic, 20

E

- economic growth, 156
- endogenous growth theory, 166
- Engle and Granger (EG), 65
- ex-ante version of PPP, 128
- exchange rate, 115
- exploratory data analysis (EDA), 98

F

- F1 score, 104
- feature engineering (FE), 99
- feature extraction, 98
- features, 75
- feature selection, 98, 99, 100
- financial account, 134
- first differencing, 55
- fiscal policy, 136
- fitting curve, 106
- flow mechanism, 134
- forecasting, 51
- forward contract, 116
- forward discount, 120
- forward exchange rate, 116
- forward premium, 120
- forward propagation, 85
- F-statistic, 12

full model, 10

G

generalize, 78

generalized linear models (GLMs), 102

grid search, 107

ground truth, 102

growth accounting relation, 158

H

heteroskedasticity, 16

heteroskedasticity-consistent standard errors, 19, 20

hierarchical clustering, 84

high-leverage points, 23

human capital, 161

hyperparameters, 75, 107

I

immigration, 160

incentives to private investment, 167

influential data points, 23

in-sample forecasts, 51

instability, 52

intercept dummy, 25

intercept term, 3

international Fisher effect, 127

intervention in the FX market, 139

K

k-fold cross validation, 79

k-means clustering, 84

k-nearest neighbor (KNN), 81

kurtosis, 133

L

labor force, 160
labor force participation, 160
labor productivity, 156
lag, 60
learning curve, 78
least absolute shrinkage and selection operator (LASSO), 80
lemmatization, 97
likelihood ratio (LR), 29
linear trend, 39
logistic regression model, 27
logit model, 27
log-linear trend model, 43, 67

M

machine learning (ML), 75
mark-to-market value, 122
maximum likelihood estimation, 27
mean reversion, 50
mean-reverting level, 50
metadata, 95
method selection, 102
model fit, 49
model misspecification, 13
monetary approach, 137
monetary policy, 136
multicollinearity, 20
multiple regression, 1, 16
 assumptions, 4
 assumption violation, 16
 formulation, 3
 interpretation, 3
Mundell-Fleming model, 135
mutual information (MI), 100

N

name entity recognition (NER), 101
natural resources, 159
negative serial correlation, 19
neoclassical growth theory, 164
nested models, 10
neural networks (NNs), 76, 85, 102
neurons, 85
Newey-West corrected standard errors, 20
N-grams, 97, 101
nonstationarity, 52
normalization, 96

O

omitting a variable, 15
one-hot encoding (OHE), 99
ordinary least squares (OLS), 40
outliers, 23
out-of-sample forecasts, 51
overfitting, 8, 78

P

parameters, 107
parity conditions, 129
partial slope coefficient, 3
parts of speech (POS), 101
penalized regressions, 80
physical capital, 161
pooling data, 16
portfolio balance (asset market) approach, 138
portfolio balance mechanism, 135
positive serial correlation, 19
potential GDP, 154
precision, 104
principal component analysis (PCA), 84, 99
pruned, 82
public infrastructure, 162
purchasing power parity (PPP), 127

pure monetary model, 137

p -value, 2

Q

qualitative dependent variable, 27

R

random forest, 83

random walk process, 53

README files, 95

real interest rate parity, 127

recall, 104

receiver operating characteristic (ROC), 104

regression analysis, 16, 17

- heteroskedasticity, 17

- model misspecification, 13

regression assumptions, 16

regression model specification, 13

regular expression (regex), 96

regularization, 80

reinforced learning, 76

reinforcement learning (RL), 86

relative dynamism (rd), 155

relative purchasing power parity, 128

residual, 2

residual plot, 17

restricted model, 10

robust standard errors, 19, 20

root mean squared error (RMSE), 52, 68

root mean square error (RMSE), 105

R^2 , 8

- adjusted, 8

- coefficient of determination, 8

S

Savings and investment, 153
scaling, 96
scaling variables, 15
seasonality, 59
seasonal lag, 60
serial correlation, 19
skewness, 133
slope dummy, 25
spot exchange rate, 116
standardization, 96
statistical inferences, 47
steady state growth rate, 164
stemming, 97
structural change, 66
structured data, 93
studentized residuals, 23
summation operator, 85
supervised learning, 76
support vector machine (SVM), 81, 102
sustainability of economic growth, 160
sustainable growth rate, 154

T

target variable, 75
technological development, 162
technological progress, 156
term frequency, 99
test sample, 78
text preparation or cleansing, 96
text processing, 96
text wrangling, 97
time series, 39
token, 97
tokenization, 97
total factor cost, 156
total factor productivity (TFP), 156
trade barriers, 168
training dataset, 75
training sample, 78

transforming variables, 15
trend model, 39
triangular arbitrage, 118
trimming, 96
tuning, 103
Type I errors, 19, 23

U

unbiased predictor, 126
unconditional heteroskedasticity, 16
uncovered interest rate parity, 125
unit root, 54
unrestricted model, 10
unstructured data, 93
unsupervised learning, 76

V

validation sample, 78
variance error, 78, 106
variance inflation factor (VIF), 21
veracity, 93
violations of regression assumptions, 16
voting classifier, 82

W

white-corrected standard errors, 19
winsorization, 96
word cloud, 99